

Evaluation of the application of Phase Change Materials (PCM) on the envelope of a typical dwelling in the Mediterranean region



G.P. Panayiotou ^{a, b, *}, S.A. Kalogirou ^a, S.A. Tassou ^b

^a Department of Mechanical Engineering and Materials Science and Engineering, Cyprus University of Technology, 31 Arch. Kyprianou, P.O. Box 50329, 3603 Limassol, Cyprus

^b School of Engineering and Design, Brunel University, Uxbridge, Middlesex UB8 3PH, UK

ARTICLE INFO

Article history:

Received 22 December 2014

Received in revised form

8 March 2016

Accepted 11 May 2016

Available online 26 May 2016

Keywords:

PCM

Typical dwelling

Cyprus

TRNSYS

Macroencapsulated

LCC

ABSTRACT

In this work the application of macroencapsulated Phase Change Materials (PCM) on the envelope of a typical dwelling in the Mediterranean region is evaluated. This is the first time PCMs are evaluated for application under the specific climatic conditions of Cyprus. The simulation process is carried out using Transient Systems Simulation software (TRNSYS). Two types of simulations have been carried out: the energy rate control test and the temperature level control test. The energy savings achieved by the addition of the PCM layer on the envelope of the test cubicle compared to the base case (no insulation) ranged between 21.7 and 28.6%. The optimum PCM case was also combined with a common thermal insulation topology in Cyprus. The results showed that the maximum energy savings per year was achieved by the combined case (66.2%). In the temperature level control test the constructions containing PCM performed better during summer. The results of the optimum PCM case and the combined case were economically evaluated using Life Cycle Cost (LCC). The results of this analysis showed that the PCM case has a very long payback period (14 ½ years) while this is changing when it is combined with insulation where the payback period is reduced to 7 ½ years.

© 2016 The Authors. Published by Elsevier Ltd. This is an open access article under the CC BY-NC-ND license (<http://creativecommons.org/licenses/by-nc-nd/4.0/>).

1. Introduction

The use of thermal storage in buildings is of great importance since it can smooth out daily temperature fluctuations and as a result lower the energy demand for heating and cooling. A way to increase thermal inertia of buildings is by integrating or including Phase Change Materials (PCM) on the buildings envelope and thus store heat in the form of latent heat. The main advantage of latent heat storage is that it has a high storage density in small temperature interval [1]. The general principle of operation of PCMs is that they store heat using their chemical bonds when they change phase from liquid to solid and release heat and vice versa. This transformation is also done in constant temperature.

In general the PCM that can be used in building applications should have a melting temperature range between 20 and 32 °C. PCMs have been under study by many researchers around the

world for over 30 years [2–6] and thus many PCM types are available in literature while some kinds are also commercially available by a number of companies.

The main categories of PCM that can be used for this purpose are organic, inorganic and eutectics. In a very interesting and comprehensive work Cabeza et al. [1] reviewed all available PCM types along with their classification, problems and possible solutions, when these are applied in buildings. In their work Baetens et al. [7] also reviewed the state-of-the-art on the current knowledge of PCM applications in buildings.

Tyagi and Buddhi [8] gave emphasis on the ways PCM can be applied in buildings such as PCM trombe wall, PCM wallboards, PCM shutters and PCM building blocks. Their results showed that there is a great potential for reducing the energy required to cover the heating and cooling demands.

A very promising application of microencapsulated PCM is their inclusion into construction materials such as concrete. This technology was studied in depth at the University of Lleida, Spain. As part of this work, Arce et al. [9] tried to overcome the effect of severe summer conditions (temperature and solar radiation) on the PCM that potentially diminish their achievable benefits.

* Corresponding author. Department of Mechanical Engineering and Materials Science and Engineering, Cyprus University of Technology, 31 Arch. Kyprianou, P.O. Box 50329, 3603 Limassol, Cyprus.

E-mail address: gregoris.panayiotou@cut.ac.cy (G.P. Panayiotou).

Although the inclusion of PCM into buildings materials, such as concrete, is considered to have numerous advantages, it also has a very important drawback which lies to the fact that they can be used only in new buildings during the built up phase and not in retrofitting applications or renovations of existing buildings.

Despite of the fact that a great number of studies have been performed for the incorporation of PCM in several construction materials, only very few studies have been made for brick constructions. Alawadhi [10] numerically studied the application of PCM in bricks and obtained promising results concerning the reduction of heat flow to the inner space during summer.

In a comprehensive work Castell et al. [11] experimentally investigated the application of macroencapsulated PCM in two types of bricks namely conventional and alveolar bricks. Their tests were performed under real conditions using five different cubicles located in Puigverd de Lleida, Spain. Two types of experiments were performed namely the free-floating temperature test and the controlled temperature test. The results showed good behavior, energy savings and technical viability. Irrespective of the promising results, a problem was faced during the experiments with the solidification of the PCM during night time. The authors suggested that this can be overcome by implementing a cooling strategy.

In this paper the effect of the application of PCM in the thermal behavior of a typical dwelling in Cyprus which has typical Mediterranean weather conditions will be investigated theoretically using suitable models of the TRNSYS software library. The innovation of this work lies to the fact that the macroencapsulated PCM will be examined when applied to the envelope of a typical brick walled dwelling using this specific model. It is also the first time that this is evaluated and present important design challenges as the climate of Cyprus is predominantly hot and there is a requirement for both heating and cooling.

2. Model design

In this work the application of macroencapsulated PCM on the envelope of a test cubicle in Cyprus is theoretically evaluated. The simulation process is carried out using TRNSYS. The main TRNSYS component used is Type1270 which models a PCM layer located in a structural element of a dwelling. This was obtained from Thermal Energy System Specialists (TESS) Company and is described below. The TRNSYS model used for a test cubicle is shown in Fig. 1.

Type1270 is designed to interact with Type56 (building model) and can model a PCM located in any position within a wall. There are two options for setting the physical properties of the PCM, the manual option and the built-in option. In the manual option the user can specify the physical properties such as density, specific heat, melting temperature, freezing temperature, and latent heat of fusion. In the built-in option the user can utilize the built-in values of this component which concern a specific brand of PCM and the user may select a model number directly by setting a single parameter. It should be noted that Type1270 models a pure PCM (as opposed to a mixture of a PCM with an inert material). From the physical point of view, this means that the PCM is assumed to go through its freeze/thaw process at constant temperature, to have a constant specific heat in the solid phase and to have a constant specific heat in the liquid phase. During the simulation procedure the PCM used is one of those supplied in the built-in library of Type1270 and concerns a commercially available material which is evaluated in three different positions. Two kinds of simulations are carried out namely the energy rate control and the temperature level control. The PCM are also compared and combined with a common thermal insulation material in Cyprus namely a layer of thermal insulation plaster ($k = 0.051 \text{ W/m}^2\text{k}$) [12]. The cases examined are also evaluated economically through a Life Cycle

Analysis (LCC). Consequently, the optimum overall option (PCM material, position and combination with insulation) for application on the envelope of the typical model dwelling in Cyprus is determined.

3. Mathematical description of Type1270

According to TESSLibs 3-Mathematical Reference [13] Type1270 is quite simplistic mathematically and assumes that:

1. The specific heat of the PCM is constant (i.e., it does not change with temperature) when fully solid. The user defines the solid-phase specific heat.
2. The specific heat of the PCM is constant (i.e., it does not change with temperature) when fully liquid. The user defines the liquid-phase specific heat.
3. The thermal contact resistance of energy flow between the PCM layer and the standard material layers adjacent to it is negligible.
4. The freeze/thaw process occurs at a constant temperature.

When the PCM material is fully frozen, the temperature at the end of a time step is given by:

$$T_{final} = T_{initial} + \left(\frac{q_1 + q_2}{m_{PCM} \times C_{p,solid}} \right) \quad (1)$$

When the PCM material is fully thawed, the temperature at the end of a time step is given by:

$$T_{final} = T_{initial} + \left(\frac{q_1 + q_2}{m_{PCM} \times C_{p,liquid}} \right) \quad (2)$$

where:

q_1 and q_2 are the quantities of energy entering the PCM from the adjacent wall layers,
 m_{PCM} is the mass of the PCM and
 $C_{p,solid}$ and $C_{p,liquid}$ are the specific heat capacities at solid and liquid state of the PCM respectively.

When the PCM material is in transition state the final and initial temperatures are equal as the phase change occurs at a constant temperature, and Type1270 simply records how much energy the PCM has absorbed or given off. If the energy absorbed by the PCM during a particular time step exceeds the PCM's latent storage capacity then Type1270 computes how much of the energy was needed to fully melt the PCM, then applies the remaining energy to a temperature change in the liquid phase using Eq. (2). Likewise, if the PCM is giving energy to the surrounding wall layers, and if it gives more energy than has been stored in a particular time step, then Type1270 computes how much energy was required to fully solidify the PCM and applies the remaining energy to a temperature change in the solid phase using Eq. (1).

4. Input data required

4.1. Methodology for the utilization of Type1270

When using Type1270 the PCM layer can be applied in any part of a dwelling's envelope such as wall, either internal or external, and roof. For the purposes of this work the PCM layer will be applied only to the external walls and the roof and not the internal walls of the dwelling. The reason for this is that the internal walls in a detached dwelling separate conditioned spaces. The

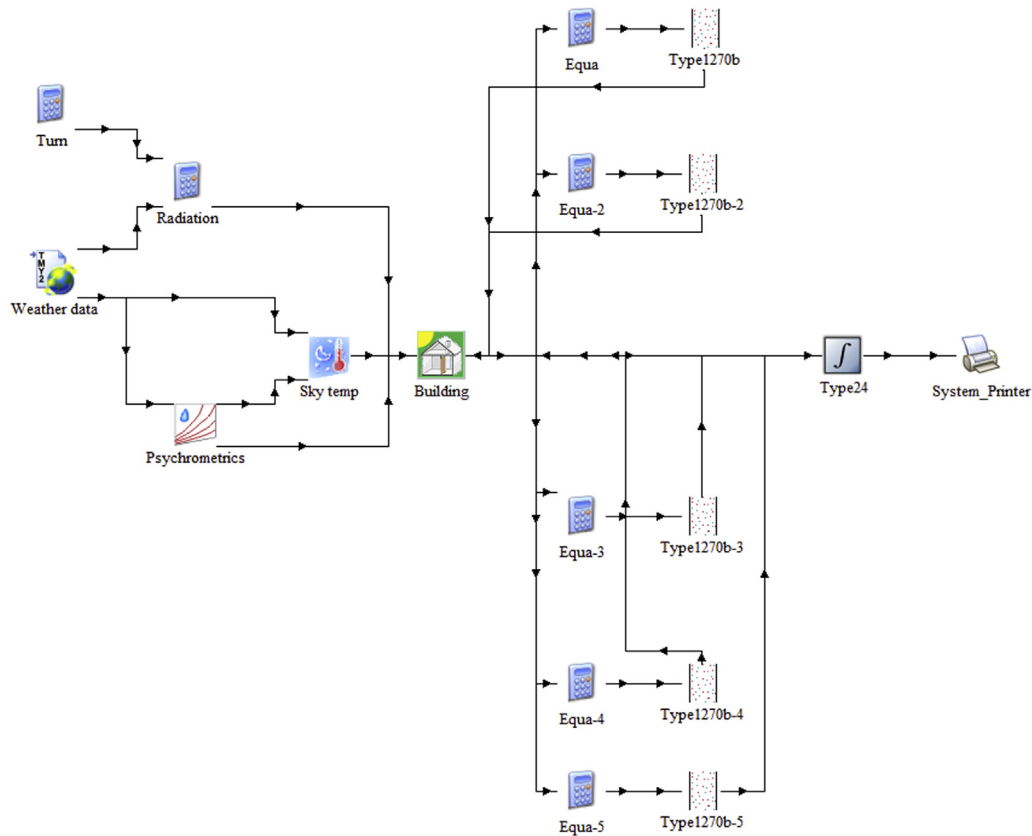

Fig. 1. Configuration of the complete model of the test cubicle with PCM.

methodology for the utilization of Type 1270 is presented in detail in [Appendix 1](#).

4.2. Position of the PCM layer

For the purposes of this paper the application of the PCM layer in three different positions is examined in order to cover both existing and new dwellings as follows:

- The PCM layer is placed in the middle of a double brick wall (this can be applied only in a new dwelling),
- The PCM layer is placed in the inner side of the wall between the brick and the plaster layer (this can be applied in both new and existing dwelling).
- The PCM layer is placed in the outer side of the wall between the brick and the plaster layer (this can be applied in both new and existing dwelling).

The dimensions of the test cubicle are $3\text{ m} \times 2\text{ m} \times 3\text{ m}$ and its orientation can be seen in [Fig. 2](#).

The three positions examined are depicted in [Figs. 3–5](#) where the parts from which each wall is split are also shown. In all cases examined, a PCM layer is also applied on the roof of the building and it is positioned in the inner side of the concrete slab just behind the plaster as shown in [Fig. 6](#). This is due to practical issues such as the protection of the material from walking on it and also the fact that it cannot be placed within the concrete slab as this will affect the structural strength of the concrete slab. This can be done only by using microencapsulated PCM as described in many articles in the literature.

4.3. Physical properties and characteristics of the PCM used

As mentioned before, during the simulation procedure the PCM used is one of those supplied in the built-in option. This PCM concerns a specific commercial product manufactured by Phase Change Energy Solutions Company. The product series of this PCM is BioPCmat™ and its product name is M91. Its physical properties and characteristics are listed in [Table 1](#). This product is offered in four different melting temperatures namely 23, 25, 27 and 29 °C. According to literature [\[9–15\]](#) the most commonly used melting temperatures for the application of PCM in hot environments is between 26 and 29 °C. Thus, in our case since Cyprus has a very hot summer and a mild winter the melting temperature of the PCM is chosen to be 29 °C.

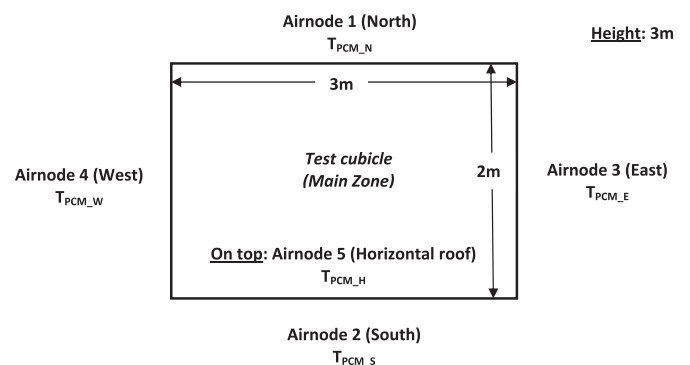

Fig. 2. Test cubicle dimensions and orientation.

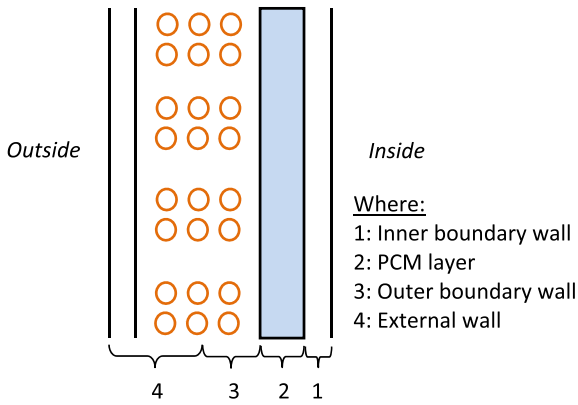

Fig. 3. PCM layer position I.

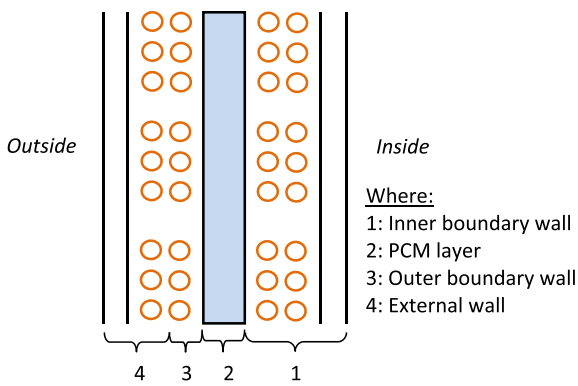

Fig. 4. PCM layer position II.

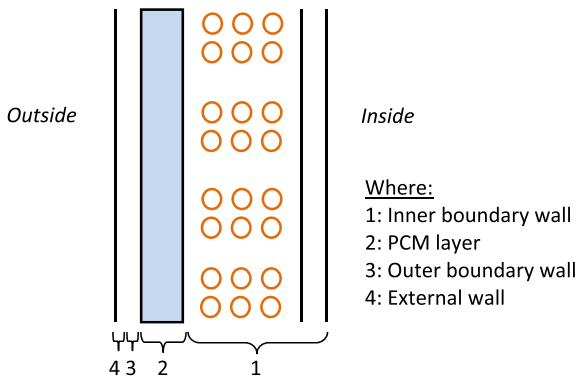

Fig. 5. PCM layer position III.

5. Methodology

Once the detailed model of the test cubicle is created the simulation is initially carried for the ‘basic case’ where the building is considered to have no insulation installed in any structural element. The simulation is carried out for a complete typical year (8760 h) lasting from the 1st of January to the 31st of December, using meteorological data for Nicosia, Cyprus [17].

The optimum PCM layer is defined using the energy rate control test, with which the total energy demand for heating and cooling are estimated. More specifically, the results of each case examined are compared to the results of the ‘basic case’ in order to calculate the consequent energy savings. In this test the set temperature for

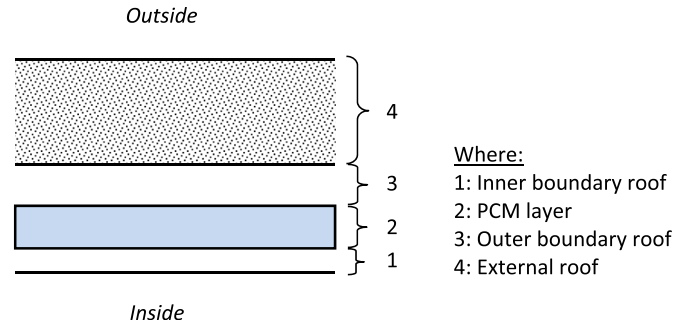

Fig. 6. PCM layer position on the roof of the test cubicle.

heating and cooling are set to be 20 °C and 26 °C respectively according to the comfort conditions for dwellings [18] while the power of the heating and cooling system is set to be unlimited in order to maintain comfort conditions at all times. The results are in the form of annual energy consumption per square meter (kWh/m²/yr). As mentioned before during the simulation the PCM is evaluated in three different positions. It should be noted that in all simulations carried out for the PCM cases the roof is considered to have a PCM layer installed in the position described in the previous section.

Once the optimum case is defined, a second simulation test is carried out, namely the temperature level control which is a test showing the effect of applying the optimum PCM layer on the fluctuation of the mean air temperature of the cubicle. In this simulation the cubicle is considered to be unconditioned and thus the heating and cooling systems are both switched off. The maximum, minimum and mean air temperature together with the number of hours where the air temperature is between comfort conditions are examined. The results of this test are presented for the coldest day of winter and the hottest day of summer which are the 3rd of February and 26th of July respectively according to the Typical Meteorological Year (TMY) used.

Additionally, a combined case is examined where the optimum PCM case is combined with a common thermal insulation topology used in Cyprus where a layer of 0.025 m of thermal insulation plaster is applied on the external walls and a layer of 0.04 m of expanded polystyrene is applied on the roof of the dwelling and the results are calculated.

Finally, the results of the optimum PCM case and the combined case are economically evaluated using LCC for the case of a complete typical dwelling in order to define the Net Present Value (NPV), the Internal Rate of Return (IRR) and the payback period of the investment. The equations used during the LCC analysis of each case are presented below as Eqs. (3) and (4) respectively.

Table 1

Physical properties and characteristics of the PCM used during the simulation procedure [16].

Melting temperature ^a	29 °C
Product	M91
Thickness (mm)	14
Weight per unit area (kg/m ²)	6.15
Dimensions/Width (mm)	419.1
Latent heat storage capacity (J/g) ^b	165–200

^a The temperatures shown in the product’s table are close proximities of the ‘true’ melting temperatures since PCMs are melting within a small range of temperatures.

^b Depending on formulation and application of the product.

$$NPV(i, N) = \sum_{t=0}^N \frac{R_t}{(1+i)^t} \quad (3)$$

where:

t is the time of the cash flow

i is the discount rate and

R_t is the net cash flow, i.e., cash inflow – cash outflow, at time t

$$0 = P_0 + \frac{P_1}{(1+IRR)} + \frac{P_2}{(1+IRR)^2} + \frac{P_3}{(1+IRR)^3} + \dots + \frac{P_n}{(1+IRR)^n} \quad (4)$$

where: P_0, P_1, \dots, P_n equals the cash flows in periods 1, 2, ... n , respectively and IRR equals the project's internal rate of return.

The economic data used for the LCC analysis are listed in Table 2 below.

6. Analysis of the results

The results of the energy rate control and the temperature level control simulations are presented separately. The various cases examined in both simulations are as follows:

- Base case - No insulation, no PCM
- PCM case - No insulation, only PCM used
- Insulation case - Insulation used in both walls and roof, no PCM
- Combined case - PCM with insulation

6.1. Energy rate control

The simulation results show that for the energy rate control for the base case the energy demand for heating is 265.5 kWh/m² yr, for cooling is 149 kWh/m² yr and the total energy demand is 414.5 kWh/m² yr.

The results concerning the energy rate simulation for the 3 PCM cases examined (three positions considered) are presented in Table 3. In all cases where the total energy savings are reported these are estimated by comparing the energy demand of the 'base case' with the case examined. As it can be seen the optimum PCM case is that in position III where the overall energy savings achieved is 28.6% (118.5 kWh/yr/m²). Additionally, this case has the highest energy saving percentage in both heating and cooling, which are 23.6% (62.6 kWh/yr/m²) and 37.5% (55.9 kWh/yr/m²) respectively.

As expected, the energy savings in cooling mode are much higher than those of heating since essentially the PCM solidification/melting procedure is operating much better under summer conditions where temperatures are over the PCM melting temperature. As aforementioned, the melting temperature of this PCM material is 29 °C and thus it is not possible to work well in winter where a melting temperature of 21 °C would be more appropriate. Nevertheless, the reasons it is working in winter is due to the fact that the space is conditioned and a part of the heat is absorbed by

the PCM and released with a time lag and this is contributing to the decrease of the heating demand and also due to the absorption of heat from the incident solar radiation which is released when the temperature drops.

The simulation results of the energy rate control concerning the combined case and the insulation case are presented in Table 4 where it can be observed that the combined case achieves slightly higher energy savings than the insulation case (66.2% instead of 61%). Nevertheless, the additional energy savings achieved when PCM is applied on an insulated dwelling, range between 5 and 7% which are economically evaluated in the following section.

6.2. Temperature level control

The simulation results of the temperature level control for the coldest day of winter (3rd of February) and the hottest day of summer (26th of July) are depicted in Figs. 7 and 8 respectively. In these figures the free-floating temperature for the base case (no insulation), the optimum PCM case, the insulation case and the combined case are plotted.

The optimum solution for the winter conditions is the insulation case followed by the combined case. The insulation case has a difference 2.5–3 °C when compared with the base case. The combined case has a difference between 0.8 and 1 °C when compared with the insulation case. When the combined case is compared with the base case it shows a difference between 2 and 2.5 °C. The optimum PCM only case has a difference of about 1 °C when compared to the base case.

During summer time the optimum solution is the combined case where the PCM is combined with the insulation. It should also be noted that the mean air temperature of the test cubicle in this case is much smoother than in all other cases and it is also 3–5 °C lower than the base case (no insulation). A very interesting thing to observe is the fact that the mean air temperature of the insulation case between 04:00–12:30 is exceeding the mean air temperature for the base case due to the fact that the heat that entered the space is trapped into the cubicle and cannot escape to the exterior. However, when a PCM layer is installed on the walls and roof this is not happening while this case is also slightly better than the insulation case with a difference between 0.1 and 1.1 °C.

According to the results of both simulations the most attractive solution to be applied in a dwelling in Cyprus is the combined one, where the PCM is used together with thermal insulation and thus the benefits of using both materials are combined.

7. Life Cycle Cost (LCC) analysis

As mentioned above the LCC is carried out for a complete typical Cypriot dwelling by extrapolating the results of the energy rate control for the test cubicle. The lifetime of the materials used according to the National Methodology in Cyprus is 30 years [23] while according to the manufacturer of the PCM is 87.2 years [16]. Since the PCM is going to be incorporated into the building materials the lifetime used for the calculations is that of 30 years. The typical dwelling used is that defined by Panayiotou [24] which is described below.

Table 2
Economic data used for the LCC.

Current price of electricity in Cyprus without VAT and additional taxes (€/kWh) [19]	0.146
Discount rate (%) [20]	5.74
Annual increase in electricity price (%) [21]	3.00
Interest rate (%) [22]	5.40

Table 3
Results of the energy rate control simulation for the PCM examined (PCM case).

PCM material		2991	
		Q _{HEAT}	Q _{COOL}
Position I	Heating and cooling demand per m ² (kWh/yr m ²)	224.7	99.3
	Total energy demand (kWh/yr m ²)	324	
	Heating and cooling energy savings per m ² (kWh/yr m ²)	40.8	49.7
	Total energy savings (kWh/yr m ²)	90.5	
	Heating and cooling energy savings percentage per m ² (% kWh/yr m ²)	15.4%	33.4%
Position II	Total energy savings percentage (% kWh/yr m ²)	21.8%	
	Heating and cooling demand per m ² (kWh/yr m ²)	225.7	99.2
	Total energy demand (kWh/yr m ²)	324.8	
	Heating and cooling energy savings per m ² (kWh/yr m ²)	39.8	49.8
	Total energy savings (kWh/yr m ²)	89.7	
Position III	Heating and cooling energy savings percentage per m ² (% kWh/yr m ²)	15%	33.4%
	Total energy savings percentage (% kWh/yr m ²)	21.6%	
	Heating and cooling demand per m ² (kWh/yr m ²)	202.9	93.1
	Total energy demand (kWh/yr m ²)	296	
	Heating and cooling energy savings per m ² (kWh/yr m ²)	62.6	55.9
	Total energy savings (kWh/yr m ²)	118.5	
	Heating and cooling energy savings percentage per m ² (% kWh/yr m ²)	23.6%	37.5%
	Total energy savings percentage (% kWh/yr m ²)	28.6%	

Table 4
Results of the energy rate control simulation for the combined and the insulation cases.

Examined case	Combined case		Insulation case	
	Q _{HEAT}	Q _{COOL}	Q _{HEAT}	Q _{COOL}
Heating and cooling demand per m ² (kWh/yr m ²)	89.9	50.3	64.3	97.6
Total energy demand (kWh/yr m ²)	140.2		161.9	
Heating and cooling energy savings per m ² (kWh/yr m ²)	175.6	98.7	201.2	51.4
Total energy savings (kWh/yr m ²)	274.3		252.6	
Heating and cooling energy savings percentage per m ² (% kWh/yr m ²)	66.1%	66.3%	75.8%	34.5%
Total energy savings percentage (% kWh/yr m ²)	66.2%		61.0%	

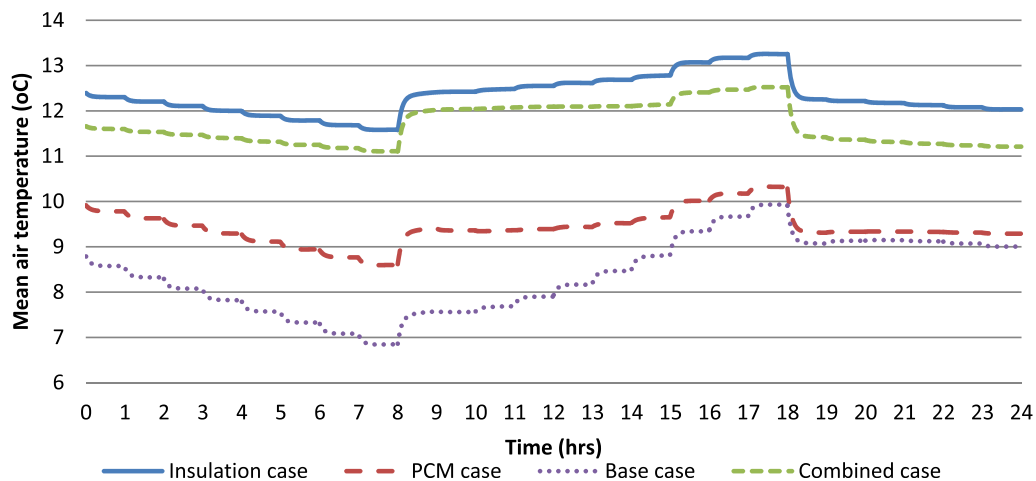

Fig. 7. Mean air temperature for all cases examined during the 3rd of February.

The typical dwelling is a single storey detached house located in Nicosia (Low mainland area) with a total area of 133 m². There are 4 persons living in the dwelling and it does not have any kind of thermal insulation installed on its envelope. It consists of three bedrooms, a kitchen, a living room, a bathroom, and a dining room. For the production of domestic hot water (DHW) a solar water heating system is used while the heating and cooling energy demands are served by split type air-conditioning units. The windows of the dwelling are double-glazed with common (no thermal brakes) aluminium frame; the main entrance door is made of wood

while the kitchen door is made of aluminium frame and glass. Finally, the floor is in contact with the ground and is covered with marbles. The plan view of the typical dwelling is shown in Fig. 9.

7.1. Optimum PCM case

The cost of the optimum PCM case was estimated using the online calculator provided by the manufacturer [16] and was €22,490. According to the estimations of the LCC for the optimum PCM case the payback period of the investment is calculated to be

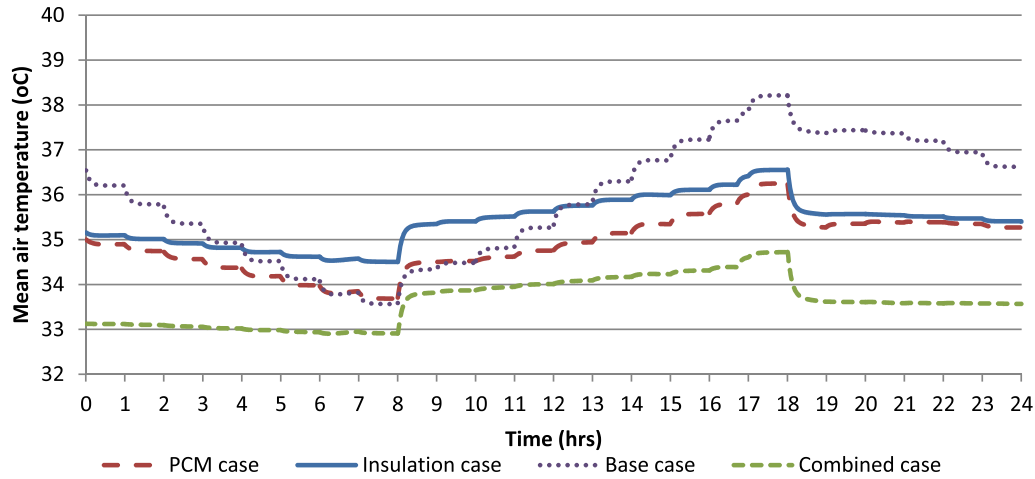

Fig. 8. Mean air temperature for all cases examined during the 26th of July.

14 ½ years, the economic benefit at the end of the lifetime of the materials used, expressed as NPV, is €35,942 and the IRR is only 4%.

7.2. Combined case

The cost of the combined case was calculated to be €23,259. The results of the LCC for the combined case showed that the payback period of the investment is calculated to be 7 ½ years, the economic benefit at the end of the lifetime of the materials used, expressed as NPV, is €110,416 and the IRR is 14%.

8. Validation of the results

The results of this study compare well with other studies as presented in Table 5. As can be seen the estimated energy saving during the winter period is slightly higher than that of other studies. During summer period the estimated energy saving is also higher, as expected, compared to that of other studies. A possible

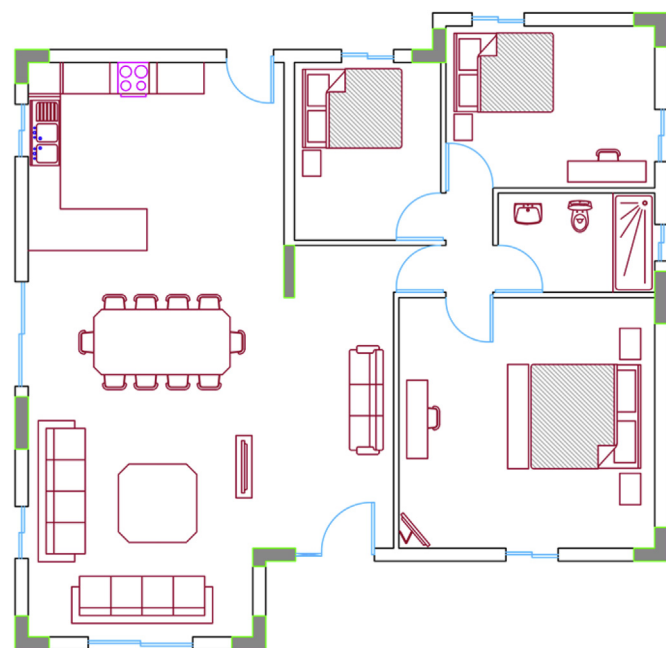

Fig. 9. Plot of the typical dwelling of Cyprus used in LCC [24].

explanation is that the maximum ambient air temperature in Nicosia in summer is much higher than that of the other location (Campinas [25]) and thus the energy saving is also higher. The result concerning the reduction of the mean interior air temperature is in very good agreement with those of the other studies most of which are experimental. Thus, it is proved that the behavior of the PCM is modeled accurately with the temperature level control simulation used in this study.

9. Conclusions

In this work the application of macroencapsulated PCM on the envelope of a test cubicle in Cyprus was theoretically evaluated. The PCM employed during the simulation process had a melting temperature of 29 °C.

The results of the energy rate control showed that the optimum position of the PCM layer when applied to an external wall is between the outer side of the brick towards the exterior environment and the plaster layer. This happens due to the fact that in this position the PCM is exposed to the outer conditions such as temperature difference and solar radiation and thus it is more active. In this case an energy saving of 28.6% was achieved.

The optimum PCM case was then combined with a thermal insulation topology used in Cyprus (thermal insulation plaster) and the results showed that an energy saving of 67.6% can be achieved. The difference between the insulation only case and the combined case ranged between 2.7 and 6.6%.

In the temperature level control simulation the case containing PCM performed better in summer while during winter as expected it did not work that well. Specifically, during winter period the optimum case is the insulation-only followed by the combined. On the contrary during summer time the optimum case is the combined where the mean air temperature is 3–5 °C lower than the base case.

The savings that will occur if the optimum PCM layer is applied on the envelope of the typical dwelling were estimated and the results showed that the highest energy and money savings are achieved by the combined case and are 20,567 kWh/yr, 3003 €/yr respectively.

Finally, the results of the optimum PCM case and the combined cases were economically evaluated using LCC. The results showed that the case employing only PCM is not considered to be a very attractive solution in monetary terms, due to the combination of the high initial cost and the annual money saving which results to a

Table 5
Results of other PCM studies for the validation of the results.

Authors	Kind of study	Location	Type of test building/facility	Energy savings		Mean air temperature reduction
				Heating	Cooling	
Ismail and Castro [25]	Experimental and theoretical	Campinas, BR	Small room (1.25 m × 1.80 m × 1.70 m)	–	31%	–
Athienitis et al. [26]	Experimental and theoretical	Montreal, CA	Test room	15%	–	4 °C
Kong et al. [27]	Experimental	Tianjin, CH	Test rooms (2 m × 2 m × 2.4 m)	–	–	1–3 °C
Cabeza et al. [28]	Experimental	Puigverd of Lleida, ES	Test cubicles (2 m × 2 m × 3 m)	–	–	2 °C
Ibáñez et al. [29]	Experimental and theoretical	Puigverd of Lleida, ES	Energy storage laboratory test rig	–	–	3 °C
Current study	Theoretical	Nicosia, CY	–	23.5%	37.4%	2.5–3 °C

very long payback time of 14 ½ years. This is not the case when the PCM is combined with thermal insulation where the payback period is reduced to 7 ½ years.

From the results of this work it is concluded that the application of macroencapsulated PCM on the envelope of dwellings located in predominantly hot environments, like Cyprus is considered to be an attractive solution in terms of energy saving and sustainable development while in monetary terms it is not yet attractive.

Appendix I. Methodology for the utilization of the PCM model (Type 1270)

Initially it is required that a direct contact airnode is introduced in each wall and the roof of the cubicle (main zone). The direct contact airnode is essentially a zone that has the same dimensions

heat transfer coefficient by convection of the side in contact with the PCM layer is set to be 0.0001 kJ/hm²K indicating direct contact in order to force the surface temperature of the wall to be equal to the boundary temperature.

A BOUNDARY wall, in terms of Type56, is a wall having a known external boundary condition such as surface temperature. Accordingly, an input named T_{PCM} is defined which represents the boundary temperature of the sides of these walls which are in contact with the PCM layer. Then, the flux of energy that crosses the outside surface of each BOUNDARY wall is connected from Type56.

The PCM model takes the two energy inputs from Type56 and computes the temperature of the PCM layer at each time step previously defined. This temperature is then passed back to the Type56 T_{PCM} input and the iterations carry on until the end of the simulation time. The modelling concept is schematically shown in Fig. 10.

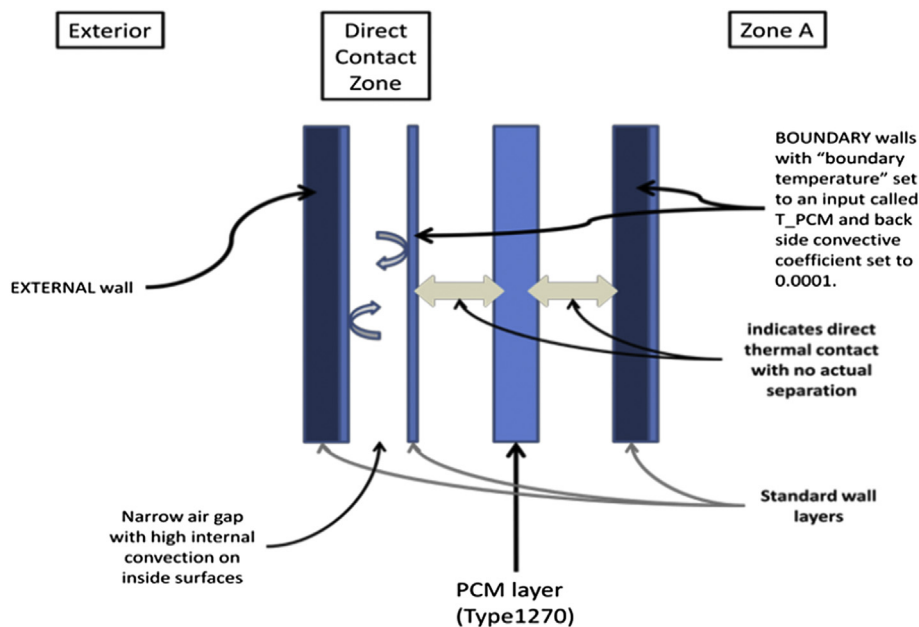

Fig. 10. Modelling concept for a PCM layer applied in an external wall [13].

(height and length) as the part examined (wall or roof) but has a width of only 0.01 m. Consequently, the wall or roof containing the PCM is split into three parts: the inner boundary part, the outer boundary part and the external part. The first part is contained in the main zone, while the other two in the airnode. The inner boundary part is the part of the wall or roof that is in contact with the inner surface of the PCM layer while the outer boundary part is the part of the wall or roof that is in contact with the outer surface of the PCM layer. The first two parts are set as BOUNDARY and the

References

- [1] L.F. Cabeza, A. Castell, C. Barreneche, A. De Gracia, A.I. Fernández, Materials used as PCM in thermal energy storage in buildings: a review, *Renew. Sustain. Energy Rev.* 15 (3) (2011) 1675–1695.
- [2] I.O. Salyer, A.K. Sircar, R.P. Chartoff, D.E. Miller, Advanced phase-change materials for passive solar storage applications, in: *Proceedings of the Solar*

- Building Conference, Silver Spring, Washington DC, USA, 1985.
- [3] M.M. Shapiro, D. Feldman, D. Hawes, D.P.C.M. Banu, Thermal storage in drywall using organic phase-change material, *Passive Sol. J.* 4 (4) (1987).
- [4] M.W. Babich, R. Benrashid, R.D. Mounts, DSC studies of new energy storage materials. Part 3. Thermal and flammability studies, *Thermochim. acta* 243 (2) (1994) 193–200.
- [5] B. Zalba, J.M. Marín, L.F. Cabeza, H. Mehling, Review on thermal energy storage with phase change: materials, heat transfer analysis and applications, *Appl. Therm. Eng.* 23 (3) (2003) 251–283.
- [6] A.M. Khudhair, M.M. Farid, A review on energy conservation in building applications with thermal storage by latent heat using phase change materials, *Energy Convers. Manag.* 45 (2) (2004) 263–275.
- [7] R. Baetens, B.P. Jelle, A. Gustavsen, Phase change materials for building applications: a state-of-the-art review, *Energy Build.* 42 (9) (2010) 1361–1368.
- [8] V.V. Tyagi, D. Buddhi, PCM thermal storage in buildings: a state of art, *Renew. Sustain. Energy Rev.* 11 (6) (2007) 1146–1166.
- [9] P. Arce, C. Castellón, A. Castell, L.F. Cabeza, Use of microencapsulated PCM in buildings and the effect of adding awnings, *Energy Build.* 44 (2012) 88–93.
- [10] E.M. Alawadhi, Thermal analysis of a building brick containing phase change material, *Energy Build.* 40 (3) (2008) 351–357.
- [11] A. Castell, I. Martorell, M. Medrano, G. Pérez, L.F. Cabeza, Experimental study of using PCM in brick constructive solutions for passive cooling, *Energy Build.* 42 (4) (2010) 534–540.
- [12] G.P. Panayiotou, Thermal performance of Dwellings in Cyprus and Approaches for Energy Conservation (PhD thesis), Brunel University, 2014.
- [13] TESSLibs 3–Mathematical Reference, 2012.
- [14] C. Barreneche, M.E. Navarro, A.I. Fernández, L.F. Cabeza, Improvement of the thermal inertia of building materials incorporating PCM. Evaluation in the macroscale, *Appl. Energy* 109 (2013) 428–432.
- [15] M. Ibáñez, A. Lázaro, B. Zalba, L.F. Cabeza, An approach to the simulation of PCMs in building applications using TRNSYS, *Appl. Therm. Eng.* 25 (11) (2005) 1796–1807.
- [16] Phasechange, 2013. Retrieved May 01, 2013, from: <http://www.phasechange.com.au>.
- [17] S.A. Kalogirou, Generation of typical meteorological year (TMY-2) for Nicosia, Cyprus, *Renew. Energy* 28 (2003) 2317–2334.
- [18] CIBSE, Guide A: Environmental Design, 2006.
- [19] EAC, Annual Report 2013, Electricity Authority of Cyprus, 2013 (in Greek).
- [20] Ministry of Commerce, Industry and Tourism, Tool for the Calculation of Cost-benefit Analysis for Energy Upgrades of New and Existing Buildings, 2012.
- [21] P. Capros, L. Mantzos, N. Tasios, A. De Vita, N. Kouvaritakis, EU Energy Trends to 2030: Update 2009, Publications Office of the European Union, 2010.
- [22] Ministry of Finance of the Republic of Cyprus, 2011. Retrieved December, 2012, http://www.mof.gov.cy/mof/mof.nsf/page17_arch_gr/page17_arch_gr?OpenDocument.
- [23] CYS EN 15459:2007, Energy performance of buildings, *Econ. Eval. Proced. Energy Syst. Build.* (2007).
- [24] G.P. Panayiotou, Thermal Performance of Dwellings in Cyprus and Approaches for Energy Conservation (Ph.D. thesis), Brunel University, London, UK, 2014.
- [25] K.A.R. Ismail, J.N.C. Castro, PCM thermal insulation in buildings, *Int. J. Energy Res.* 21 (14) (1997) 1281–1296.
- [26] A.K. Athienitis, C. Liu, D. Hawes, D. Banu, D. Feldman, Investigation of the thermal performance of a passive solar test-room with wall latent heat storage, *Build. Environ.* 32 (5) (1997) 405–410.
- [27] X. Kong, S. Lu, J. Huang, Z. Cai, S. Wei, Experimental research on the use of phase change materials in perforated brick rooms for cooling storage, *Energy Build.* 62 (2013) 597–604.
- [28] L.F. Cabeza, C. Castellon, M. Nogues, M. Medrano, R. Leppers, O. Zubillaga, Use of microencapsulated PCM in concrete walls for energy savings, *Energy Build.* 39 (2) (2007) 113–119.
- [29] M. Ibáñez, A. Lázaro, B. Zalba, L.F. Cabeza, An approach to the simulation of PCMs in building applications using TRNSYS, *Appl. Therm. Eng.* 25 (11) (2005) 1796–1807.