



Micro-flexibility: Challenges for power system modeling and control[☆]

Spyros Chatzivasileiadis^{a,*}, Petros Aristidou^{b,1}, Ioannis Dassios^{c,1}, Tomislav Dragicevic^{a,1}, Daniel Gebbran^{a,1}, Federico Milano^{c,1}, Claudia Rahmann^{d,1}, Deepak Ramasubramanian^{e,1}

^a Technical University of Denmark, Denmark

^b Cyprus University of Technology, Cyprus

^c University College Dublin, Ireland

^d University of Chile, Chile

^e Electric Power Research Institute, USA

ARTICLE INFO

Keywords:

Granularity
Stochastic systems
Zero-inertia
Power electronics

ABSTRACT

This paper collects the challenges and opportunities that emerge from the millions of controllable devices – and the micro-flexibility they offer – that are deployed across the transmission and distribution systems. Moving to power systems that are dominated by converter-interfaced resources poses both threats and opportunities. On the one hand, new dynamic phenomena and types of instability arise and there is need for advanced simulation tools. On the other hand, these devices allow for a massive decentralized and direct response to disturbances. The emerging power system paradigm aims to tap the flexibility potential of the millions of controllable devices to ensure the safe operation of power systems. To achieve that, however, we first need to address a range of modeling and control challenges. This paper attempts to identify and describe these challenges.

1. Introduction

Over the past few years, we have witnessed two major trends in power systems. First, the proliferation of converter-based resources across all voltage levels: From laptops, motors, home batteries, and heat pumps at the building-level, to electric vehicles and energy storage at the distribution level, and to High-Voltage DC (HVDC) converters and Flexible AC Transmission Systems (FACTS) (e.g. STATCOMs) at the transmission level [1–6]. Being interfaced through power electronic converters, all these devices offer unique control capabilities and are key components to extract the micro-flexibility available at large over distributed resources [7]. Second, the continuously increasing interconnectivity across devices and resources. WiFi, 4G/5G/6G, and dedicated communication channels open new avenues for remote sensing and coordinated control across wide areas [8].

Besides creating an interface that allows harnessing the flexibility within each energy resource, power converters can also provide advanced technical functions such as reactive power support, harmonic

compensation, and phase imbalance restoration, by creating different control set-points in the converter's switching operation [9]. Combined with appropriate local or coordinated control approaches, and taking advantage of the communication infrastructure, it is possible to utilize the most out of both the active power flexibility present in the end-application, as well as reactive power and other resources available in each converter.

This paper investigates the challenges that arise from micro-flexibility and identifies the needs for further work in order to deliver solutions that can capture well the recently appearing dynamic phenomena and harness the available micro-flexibility. In particular, the paper discusses how the dynamic behavior and control of these millions of devices impacts on the dynamic response of the power system and how system operators take advantage of their controllability.

To better describe the challenges that lie ahead, we discuss first a simple example that occurred in the German power system over the past decade.

[☆] F. Milano and I. Dassios are supported by the FRESLIPS project, funded by the Sustainable Energy Authority of Ireland (SEAI), Grant Agreement No. RDD/00681. F. Milano is also supported by the edgeFLEX project, funded by the European Commission Horizon 2020 program, Grant Agreement No. 883710. S. Chatzivasileiadis is supported by the ID-EDGE project, funded by Innovation Fund Denmark, Grant Agreement No. 8127-00017B, and by the FLEXGRID project, funded by the European Commission Horizon 2020 program, Grant Agreement No. 863876.

* Corresponding author.

E-mail addresses: spchatz@dtu.dk (S. Chatzivasileiadis), petros.aristidou@cut.ac.cy (P. Aristidou), ioannis.dassios@ucd.ie (I. Dassios), tomdr@dtu.dk (T. Dragicevic), dgeco@dtu.dk (D. Gebbran), federico.milano@ucd.ie (F. Milano), crahmann@ing.uchile.cl (C. Rahmann), dramasubramanian@epri.com (D. Ramasubramanian).

¹ All authors contributed equally.

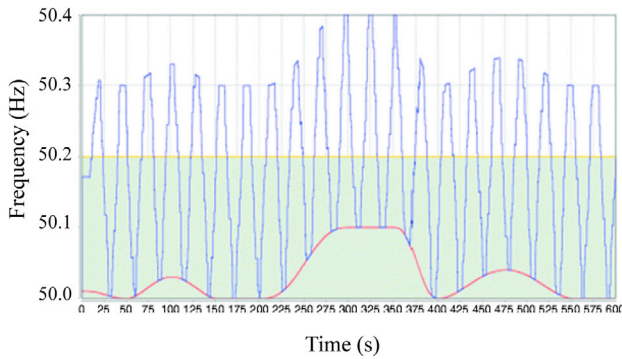

Fig. 1. “Flapping” caused by the so-called German 50.2 Hz problem (blue line): Large fleets of solar PV generators turning off when frequency exceeds 50.2 Hz; this leads frequency to drop down to 50 Hz; in turn, solar PVs reconnect leading frequency to exceed 50.2 Hz again, causing the “flapping”. The red line shows what the system frequency would have been with the solar PVs permanently disconnected [11].

1.1. The German 50.2 Hz problem

In 2007, the German regulator issued the directive EN50438:2007, which stipulated that all micro-generators must turn off, should the frequency exceed 50.2 Hz. This was considered as a mitigation measure that would help deploy less primary frequency reserves from conventional sources and reduce costs. However, what was not considered at that point is that the amount of solar PV generators would dramatically increase over the next few years [10]. The combined response to over-frequency events of large fleets of solar PV generators led to the so-called phenomenon of *flapping* [11].

As shown in Fig. 1, the moment frequency exceeded 50.2 Hz, a large number of PV generators disconnected, driving the system frequency down to almost 50 Hz. Having a naive closed loop control implemented, the moment solar PVs sensed that frequency is below 50.2 Hz, they reconnected driving it again beyond limits. This has led at times to significant frequency oscillations in the German system, until a new directive was issued that required a more continuous droop-based response to the frequency signal from the micro-generators, instead of the discrete on/off behavior they had so far [11].

But, what were the drivers that led to “flapping”? There are five main reasons:

- (1) *Discrete on/off behavior* of the solar PV generators. Continuous control would have a much smoother response and avoid this oscillatory behavior.
- (2) *Stochasticity* of the solar PV generation: if the operator were able to accurately predict the amount of solar PVs in the system, they would commit less conventional sources and avoid any overfrequency events.
- (3) *Population size*. Smaller PV populations would not have such a considerable effect on the system frequency.
- (4) *Uncoordinated, local, and naive closed loop control*, which led to an undesirable synchronized response across the whole system. Should the control have been (i) open-loop, the solar PVs would have only disconnected once and not reconnect; (ii) coordinated through e.g. communication signals, only a desired amount of solar PVs would disconnect; (iii) non-naive, e.g. by adding a random delay to the local control to reconnect, the flapping would have been avoided.
- (5) *Time delays* related to lags in measurement and/or action: if the solar PVs were able to measure the frequency every 1 millisecond and react directly, the amplitude of the frequency oscillation would have been much smaller. Of course this implies significantly increased costs in sensing technology and actuators.

Some or all of these five drivers do not characterize solar PVs only, but they rather transcend across a wide range of controllable devices, such as heat pumps, electric vehicles, any type of motor drives, battery storage, and others. Considering the proliferation of these devices and the significant impact they can have to the grid operation, the goal of this paper is to discuss how we shall model both the individual devices and the whole system, considering their intrinsic characteristics the challenges and opportunities that arise with respect to the power system modeling and control.

1.2. Scope of this paper

This paper focuses on how the intrinsic characteristics and control of these devices affect our ability to simulate and assess the stability of power systems. We first discuss the modeling and control of the inverter-based resources, which are the key tools to extract the micro-flexibility. In particular, we discuss opportunities and challenges from the shift to discrete and stochastic modeling and control. Then we move to the impact these millions of micro-devices have on the macro-level, discussing the challenges arising from developing computationally tractable aggregate and equivalent models that include large families of such devices. Our aim is to identify and discuss emerging challenges and opportunities. Although we do indicate some directions for future research, our goal is that the discussion in this paper will stimulate the reader to come up with their own innovative solutions to these pressing problems.

This paper is organized as follows. Section 2 presents the needs for new models of power system components that can capture the discrete and stochastic behavior of the micro-devices, while also considering functional aspects, such as time delays. Discussing the need for a vast standardization campaign in order to enable the widespread harnessing of micro-flexibility, Section 3 suggests that the performance requirements to be put forth by the grid operators shall be performance-based (i.e. control-agnostic). Section 4 continues outlining the communication network requirements for the control applications at different levels (buildings, distribution, transmission) along with communication time delays. Section 5 focuses on ways to capture the impact of the millions of “micro-devices” at the “macro-level”. It discusses two main ways to reduce the computational complexity, through aggregate and equivalent models, and provides concrete examples of how such models are derived in the industry. Section 6 raises the key issue of the appropriate parameterization of the equivalent models and discusses how a combination of physics-based and data-driven approaches can be appropriate. Section 7 outlines the current developments with respect to the Internet of Things (IoT) and cloud-based computing, and suggests the needs for new tools. Section 8 collects a number of case studies that demonstrate the key phenomena we discuss in this paper with concrete examples. Our goal has been to design the simplest case studies that can capture all the key phenomena we discuss throughout the paper. Finally, Section 9 provides an outlook about promising research directions to address relevant emerging challenges and opportunities.

2. Challenges for modeling and control

This section discusses how the intrinsic characteristics of the controllable devices affect our needs for power system modeling and control (i.e. discrete and stochastic behavior, time delays, population size, and control).

2.1. From continuous to discrete modeling and control

2.1.1. Conventional power system model

The transition from macro to micro systems involves a conceptually different approach of both modeling and control. Electromechanical

transients of conventional power systems were conveniently modeled using deterministic differential–algebraic equations, in the form:

$$\begin{aligned} \frac{d}{dt} \mathbf{x} &= \mathbf{f}(\mathbf{x}, \mathbf{y}, t), \\ \mathbf{0} &= \mathbf{g}(\mathbf{x}, \mathbf{y}, t), \end{aligned} \quad (1)$$

where $t \in \mathbb{R}$ is time, $\mathbf{x} \in \mathbb{R}^n$ and $\mathbf{y} \in \mathbb{R}^m$ denote the state and algebraic variables, respectively; and \mathbf{f} and \mathbf{g} are non-linear differential and algebraic equations, respectively.

Eqs. (1) represent the model that, with various degrees of simplifications and with various techniques, has been utilized for more than a century for the transient stability analysis of power systems. This model is specifically designed to account for the time scales of the electromechanical dynamic response of synchronous machines and their primary controllers while neglecting electromagnetic transients.

In recent years, modeling and control requirements have changed dramatically. One of the most relevant changes is the substantial increase of power-electronics-based devices, which have already changed and will keep changing the overall dynamic behavior of the system. The reduction of the inertia is one of the most critical aspects; another one is the change in the relevant time scales [12]. There is an ongoing debate on whether model (1) is adequate at all to study systems where the dynamics are not dominated by synchronous machines and whether other approaches, based for example on a fully-fledged electromagnetic transient models or dynamic phasors would be more appropriate when dynamics are dominated by converter-interfaced generation [13]. This debate, however, is more on the “details” of the equations than on their nature. Whatever the conclusions on how to properly model converters for system studies will be, and whether phasors will be still considered adequate at the end, this does not change the fact that the equations can still be written as a set of continuous deterministic Differential-Algebraic Equations (DAEs). The move from macro to micro, on the other hand, implies deeper conceptual changes both in the way equations are written and in the way researchers and practitioners should study the system itself.

2.1.2. Modeling granularity, discrete events, noise and delays

The aspects that are relevant in this context are (i) the “granularization” or, using a more mathematical term, “discretization” of the devices (i.e. devices that can only be controlled by switching them ‘on’ or ‘off’ require discrete variables); (ii) their stochastic behavior; and, (iii) whenever remote measurements and communications are involved in the controllers, delays in the measured signals. Considered individually, each aspect leads to a different class of DAEs with different stability and uniqueness properties.

Granularization leads, ultimately, to include discrete variables in (1) and change it into Hybrid Differential-Algebraic Equations (HDAEs). Noise and randomness can be conveniently modeled using Stochastic Differential-Algebraic Equations (SDAEs). And time delays leads to Delay Differential-Algebraic Equations (DDAEs). When merging all these features together is a set of Hybrid Stochastic Delay Differential-Algebraic Equations (HSDDAEs), whose stability, uniqueness of solution and controllability and observability properties cannot, in general, be determined analytically. One has to rely, thus, once again and even more inevitably than in the past, on numerical simulations. However, a set of HSDDAEs is not just more complex to implement and to integrate than DAEs. There are practical implications that need to be well understood before researcher first and practitioner later can effectively study and operate the system.

2.1.2.1. HDAEs. Discrete variables can be roughly divided in to two categories: (i) equations with *discontinuous right-hand side*, where the discrete variables are due to structural changes, such as the hard limits of the controllers; and (ii) *behavioral models*,² i.e., equations where

the discrete variables approximate a complex model whose details and dynamics are not relevant for capturing the overall system dynamic, i.e., the modeling of MOSFETs as simple switches. At this point, one may question why would the presence of a large number of small generators require a hybrid DAE with discrete variables, since – theoretically – we can apply continuous control to each generator. The main challenge here is the small size and large number of these generators. If we had one generator of 100 MW, it would make sense to regulate it continuously, as we have done so far. But if one has, say, 100,000 generators of 1 kW, it is probably a better idea to connect/disconnect the generators whenever needed. This of course applies to any controllable device. The question that remains open and shall be addressed by the modeler in each case is the size at which one wants to switch from continuous to discrete control.

In the context of this survey, the most relevant category is that of behavioral models. For this class of models there exists a well-assessed formalism based on Discrete-Events Systems (DEVS) and the extensions to hybrid continuous and discrete-event systems has formed the source of an extremely vast and diverse literature [14,15]. Interestingly, books and relevant references therein show that DEVS are in fact the most general (*universal*) way to represent a physical system. And, as a matter of fact, the continuous (1) are never really studied as such in a computer: first, time has to be discretized and then, a time integration method has to be chosen to perform the integration. As a result, continuous DAEs are always implemented as discrete-time systems, which can be shown to be a special case of DEVS. Discrete-events and/or behavioral models are a convenient and efficient way to describe digital systems. Recently, experts in DEVS have been studying power systems and their implementations using the DEVS formalism [16,17]. A relevant example is the software tools implemented at the Oak Ridge National Laboratory, USA, as well as references in [18].

The nature of discrete variables makes impossible or, at least, very difficult, to study the stability of the system. For large disturbances, the power system community is used to rely on numerical integration. Small-signal stability analysis, however, has been a work-horse of both academia and industry for the study of the properties of the operating points of (1) [19]. The well-known linearization and calculation of eigenvalues, however, cannot be applied to HDAEs, for at least two reasons: the sensitivities w.r.t. discrete variables is discrete variables are always null, and stochastic processes are never steady, and hence, one cannot define an equilibrium point. Of course, there exist techniques to overcome these issues. For example, Lagrangian relaxation allows dealing with discrete variables. The modeling of on-load tap changer transformers is a well-known “old” problem where a discrete variable (the tap ratio of the transformer) is often made “continuous” for the sake of stability analysis [20].

2.1.2.2. SDAEs. With regard to stochastic processes, one can always resort to the study of the average model, which, roughly speaking, is obtained by substituting the diffusion term of the stochastic processes with its expectation. However, these “tricks” lead ultimately to lose the added information of discrete variables and noise. For the former, the fact that discrete variables may have dynamic effects that disappear when they are relaxed (see for example the region of attraction of discrete on-load tap changers [21]; the limit cycle originated by the series of two discrete under-load tap changers described in [22]; and the real-world example described in Section 1.1). For the latter, the average model loses the information on higher order statistical moments, such as the standard deviation of the variables [23] and the potentially destabilizing effect of correlation [24] and autocorrelation [25] of stochastic processes.

using various resistances, capacitances, voltage sources and diodes. This would be the “physical” model of the MOSFET. The behavioral model, on the other hand, would be just a discrete switch (on/off) depending on the gate and source voltages.

² Please note that in electronic circuits, a behavioral model is a simple discrete model of a complex circuit. For example, SPICE models MOSFETs

2.1.2.3. DDAEs. In the context of functional differential equations, time delays also make significantly more complicated both the time domain integration (e.g., even a work-horse A-stable numerical method such as the trapezoidal method can show spurious oscillations [26]) and the small signal stability analysis (e.g., leading to state matrices of order of magnitude bigger than the conventional ones [27]). Again, also in this case, one can resort to techniques that recover the conventional DAEs model, for example, through the Padé approximants that transform a delay into a set of ordinary differential equations [27]. However, also in this case, approximations may lead to the loss of some intrinsic idiosyncrasies of the delays, such as the “quenching phenomenon” that arises in case of time varying delays [28,29]. The quenching phenomenon occurs if a system that is unstable with inclusion of a constant delay $\tau \in [\tau_{\min}, \tau_{\max}]$, can become stable for a time-varying delay $\tilde{\tau}(t)$ that varies in the same interval $[\tau_{\min}, \tau_{\max}]$, and vice versa [30]. In Section 4, we elaborate on the communication architecture across voltage levels and mention indicative values of the latencies the communication infrastructure introduces.

2.2. Opportunities for robust and scalable controllers

We have discussed so far only the modeling aspects of the new granular power systems, and we have referred to these modeling aspects mostly as issues that complicate the implementation in software tools and the stability analysis of the system itself. It would probably be a mistake however, to consider these modeling features only as issues. One can think also of the opportunities that they offer. This is particularly relevant when considering the control and the synchronization of the system. Noise and randomness is not necessarily always detrimental. Considering again the example of oscillators, stochasticity can be exploited, for example to achieve synchronization [31,32]. Delays, while generally reducing the stability margin of a system, can be utilized to improve it [33]. Most relevantly, in the context of granular power systems, randomness can also be exploited to implement effective decentralized controllers that deal well with millions of small devices that can only switch on or off.

Randomness is an important aspect that can be expected to have a special role in granular power systems. The problem to be solved is as follows. Let us assume to have a resource composed of a large number of micro devices (e.g., refrigerators, HVACs, electric vehicles, etc.) which can measure and, if needed, respond with a certain action to a quantity of the electric system (e.g., voltage or frequency). For these small devices, it is not realistic nor necessary to implement a continuous control. It is simpler and effective to simply switch the device on or off depending on the value of the measured signal. At this point, however, an issue (that does not exist in conventional continuous controllers) arises. If all devices respond in the same way and at the same time to a signal variation, then a large amount of power will switch on or off resembling a “step-wise disturbance”. This phenomenon is well-known in research fields such as traffic control and the internet, and takes the name of *flapping* [34,35].

To avoid flapping, the devices must not respond all in the same way and at the same time given the same input signal. The solution can be centralized or decentralized. In the centralized approach, the devices are coordinated by a central controller that decides which devices have to switch on and which ones have to switch off at any given time. This is an acceptable solution if the number of devices is small. The unit commitment problem is an example of centralized approach, where the central controller is the market operator. The centralized approach is not suitable, however, if the number of devices is very high, the time scale of the control is small and/or communication between the devices and the control center is high. Considering a traffic congestion example, it is impractical to implement a control that solves the congestion by gathering information on the position and the destination of all cars on the road. A decentralized approach, which does not require any communication, is the solution to be sought.

The key point of the decentralized approach is to introduce a stochastic decision process. For example, with respect to the traffic congestion, each vehicle decides whether or not to change its route based on the congestion of the road (local measurement) and the output of a probability function, whose expression is defined *a priori* and that is calculated based on the intensity of the local traffic congestion. This is an unusual case where the control is intrinsically scalable. Actually, the higher the number of devices the better, as stochastic properties are more predictable as the size of the population increases.

The implementation of a discrete decentralized stochastic controller is not straightforward. First, one has to choose a proper probability function that guarantees that the resulting control is stationary and ergodic, terms that, in the context of stochastic processes, are sort of synonyms of “steady state” and “stable” in the context of deterministic continuous dynamics. Then, the decision whether to take a certain action has to be taken periodically (e.g. at every cycle of the decentralized controller). Finally, all devices participating in the control implement the same probability function.

An example of implementation of stochastic control based on an additive-increase multiplicative decrease (AIMD) strategy for grid-connected microgrids is presented in [36]. This work shows that a stochastic control approach can work effectively and can coexist with other objectives, e.g., maximizing the economic revenue of the microgrids, provided that the conditions above are satisfied.

2.3. Challenges towards implementation in practice

The implementation of control approaches that can handle the granularity of the controllable elements in order to extract the much-needed micro-flexibility gives raise to (at least) three major challenges. First, standardization is key. At the moment, there are neither standardized “products” (e.g. for ancillary services) nor standard interconnection requirements about how controllable devices can support the grid operation. In Section 3, we elaborate on aspects pertaining to this issue, and claim that interconnection requirements shall be control-agnostic. We show that different control architectures can achieve a similar dynamic response and suggest that grid codes shall not specify the type of control to be implemented in each device, but rather focus on so-called “performance-based requirements”.

Second, when it comes to the adoption of control approaches that involve the handling of millions of devices by the system operator, the main issue is trust; operators shall be able to trust that the power reserve and frequency containment support provided by a certain class of devices is reliable and will be actually available if and when it is required by the system. Without such trust, which is in effect a trust that is based on stochastic behavior of the devices and their controllers, the system operator will have to dispatch the power reserve and the frequency containment reserve through other (possibly conventional) devices, and, in turn, making the effort of implementing the stochastic control useless.

Third, challenges to adopt these new approaches emerge also from the device owners. They will probably be motivated to buy (or activate the control of) these devices only if there is some incentive, typically a monetary reward, in the short or medium term. And, still, this cannot guarantee that the device will do the right thing at any time. It is only on average and in a sufficiently long period of time that the control operates correctly. In other words, it is possible that in specific occasions, the control will do exactly the opposite of what it should do and/or lead to an increase in the consumption and thus in the electricity bill for the owner of the device. These challenges call, on the one hand, for the design of new markets that will be able to provide the users with the right incentives to offer grid services, and on the other hand, for markets that can deal with the stochastic availability of flexible resources (e.g. reliability-aware markets [37]).

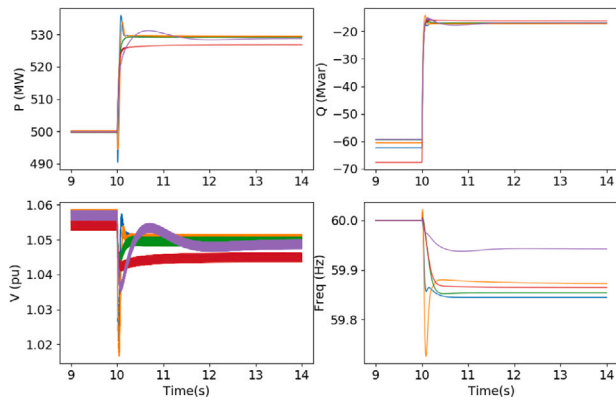

Fig. 2. Similarity in dynamic behavior of five different types of new and emerging inverter control architectures for a system islanding event [39].

3. Towards performance-based interconnection requirements

With an increase in the number of inverters, they would be expected to provide services to the power system to allow for continued reliable operation of the network. These services need not be an exact replacement of services lost from synchronous machines. While one may first be tempted to acquire a one-to-one replacement of services, the changing nature of the power system should be recognized while also acknowledging the various hierarchical levels of changes required. Further, since inverters do not inherently possess any natural characteristic and their behavior is almost completely governed by the underlying control strategy, the same services can be achieved through multiple different control architectures, each with different forms of implementations. As such, all control implementations that meet the provision of required services should be acceptable. In order to have an efficient design of the inverter control techniques, exact performance requirements must be known, which can only be specified either through standards and/or interconnection requirements from power system planners. Hence, improved focus should be laid on the development of detailed interconnection requirements.

For example, in large inverter-interfaced plants, having fast voltage control at the inverter level (as opposed to only having slow voltage control at the plant control level) can improve the stability of the inverter control system [38]. The improvement in stability can sometimes even bring about operation of 100% inverter networks. Now, this performance feature of fast voltage control at inverter level can be realized in many different ways from the perspective of control system design. Given this, and with the understanding that control system design falls under the purview of inverter equipment manufacturers, a power system planner must work towards definition of performance in interconnection requirements.

A key aspect of this form of control agnostic interconnection requirements is to intentionally not apply to black start and system restoration operation paradigms. The reason for such a distinction is due to the fact that blackstart and system restoration are special operation modes even in today's power network, and while it is possible to define control agnostic performance requirements for blackstart operation, they can be different from performance requirements during continued operation.

Due to similarity in behavior (both structurally and operationally) [40] of many new and emerging inverter control techniques, it is possible that general performance requirements can hold. An example from [39] illustrating the similarity in behavior is discussed using a single-machine infinite-bus setup with a 600 MVA inverter connected to an infinite bus through a long transmission line. At the far end of the transmission line is a 530 MW load along with the infinite bus. The dynamic behavior of five different types of new inverter control

architectures are evaluated and shown in Fig. 2. Of these five, one is virtual-oscillator-based [41], one is PLL-based [42], and three are droop-based [43,44], where each type of droop based structure itself has few differences in the implementation of its control loops. The panels in Fig. 2 have intentionally not been labeled, as the intention is not to compare the differences between new and emerging inverter control architectures but rather to show the similarity across them. Initially, the inverter is grid connected and dispatched at an active power operating point of 500 MW along with a voltage set-point of 1.05 pu. At $t = 10$ s, the infinite bus is disconnected thereby creating a 100% inverter network. The active/reactive power output of the IBR and the point of interconnection voltage magnitude with all five control structures shows a similar performance. With regard to electrical frequency in the network, four out of the five control methods have an approximate 5% frequency droop slope while the fifth has a 2% frequency droop slope. As a result, the final settling frequency of four inverters are bunched together.

While it is acknowledged that the field of future inverter design and control is very much still an active research field, the possibility of obtaining similar dynamic behavior through parameterization and tuning allows for the specification of a common performance based interconnection requirement. In fact, recent draft interconnection specifications like National Grid's draft GC0137 requirements [45] and Germany's Technical Connection Rule VDE-AR-N 4131 [46] for HVDC interconnectors have not explicitly mentioned any particular type of Inverter-Based-Resource control structure and do have some performance based requirements.

4. Communication layer: Network requirements and time delays

In this section, we first introduce the general communication architecture used in electricity grids, and then discuss the potential impact of delays in monitoring and control, all of which need to be accounted for when designing and operating future energy systems.

4.1. Communication architecture

The communication architecture of future electricity grids can be represented by a hierarchical multi-layer architecture, which is usually divided into three main tiers [2–4,6,8,47,48]:

- (1) Home Area Network (HAN).
- (2) Field Area Network (FAN) and Neighborhood Area Network (NAN).
- (3) Wide-area Network (WAN).

The HANs are short-range networks related to the end-users at consumption level, including residential, industrial, and substation loads. NANs and FANs are medium-range networks used in distribution areas. WANs are long-range networks that provide the communication platform between the electric utility and substations. Multiple HANs connects to a NAN. The NAN collects information and enables communication to the WAN [47]. The classification described is based on network coverage area, spanning the entire grid, from consumption levels to bulk generation through transmission and distribution grids. Fig. 3 illustrates these communication networks and their requirements in terms of data rate and coverage distance.

4.1.1. Home Area Networks (HAN)

At the consumption level, HANs are used to provide the communication facilities for the implementation of functionalities pertaining to energy consumption [48]. The aim of HANs is to provide home automation and communication between smart meters, appliances, Home Energy Management Systems (HEMS), solar panels, EVs, among others [47,52,53]. This in-home communication network can enable end-users to automatically and remotely control, monitor, and manage their energy consumption and production more efficiently (without

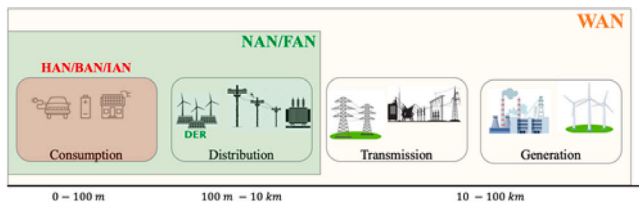

Fig. 3. Communication networks and their relationship with power system infrastructures.

Table 1
Network requirements for HAN applications.

Application	Latency	Bandwidth [kbps]	References
Home automation	200 ms–15 s	9.6–56	[8,49,50]
Efficient energy management	2 s–15 s	9.6–56	[3,8,51]
Central control of critical devices	1–20 s	14–100	[50,51]

Table 2
Network requirements for FAN/NAN applications.

Application	Latency	Bandwidth [kbps]	References
Dynamic pricing	2 s–1 min	50–100	[8,50,51]
DR	0,5 s–1 min	14–100	[3,8,50,51]
EVs	2 s–15 s	5–255	[8,50,51]
DA	1 s–5 s	9.6–100	[8,50,51]
ORM	2–20 s	25–56	[8,50,51]
SCADA	15–200 ms	10–128	[3,57,58]
AMI	2–15 s	10–500	[8,49,57]

human intervention) considering a wide range of devices such as refrigerators, washing machines, heaters, lights, air conditioners, among others [54,55].

HANs can therefore provide information to utilities about the energy consumption of end-users and access to control critical devices at the customers' premises [51]. This can help to meet energy reliability requirements and protect the grid from unwanted blackouts by directly controlling or shifting critical house loads [54,56].

Applications within HANs do not require large coverage, high speed, or high data rate, meaning that they can be managed with low power, low-cost technologies [8,47,48]. Communication technologies able to provide data rates up to 100 kbps per device with short coverage distances (up to 100 m) are enough in these applications [8,47,48,51,53]. Low latencies are also not a critical requirement [51]. Depending on the functionality, reasonable latency times for these applications can range between 200 ms and 15 s [3,8]. HANs may include wireless communication technologies such as Zigbee, Z-Wave, WiFi, or wired ones such as Power Line Communication (PLC), Fiber Optical Comm, and Ethernet [3,6,8,47,48]. Still, wireless technologies are usually preferred since they allow flexible addition/removal of devices and reduce installation costs and time [52,53]. Table 1 summarizes the requirements of HAN applications in terms of latency and communication bandwidths.

4.1.2. Field Area Networks (FANs) and Neighborhood Area Networks (NANs)

FANs and NANs are networks within the distribution domain that enable the information flow between the WANs and the HANs [47]. While in FANs the data is transmitted from field devices to substations (or vice versa), in NANs, the flow is from customers to data concentrators (or vice versa) [8].

Applications at the distribution system level can be either field-based (related to transmission lines, sensors, regulators, etc.) or customer-based (related to end customers such houses or buildings) [59]. While field-based applications include outage and restoration

Table 3
Network requirements for WAN applications.

Application	Latency	Bandwidth [kbps]	References
Wide-area motoring			
Local voltage stability	<0.1 s		
Wide-area voltage stability	<5 s		
Local power oscillations	<30 s		
Wide-area power oscillations	<0.1 s	1–5	[3,8,49,51]
PMU-based state estimation	<0.1 s		
Wide-area control			
Voltage stability control	<5 s		
Power oscillations control	<0.1 s	5–100	[3,8,60]
Closed-loop transient stability	<0.1 s		
FACTS and HVDC control	<2 min		
Wide-area protection			
Predictive under-frequency load shedding	<0.1 s	5–75	[8,57,60]
Adaptive islanding	<0.1 s		

management (ORM), supervisory control and data acquisition (SCADA) applications, DER monitoring and control, among others, customer-based applications include the communication between Advanced Metering Infrastructure, demand response (DR), load management system, metering data management system, among others [59]. The deployment of Advanced Metering Infrastructure in NANs allows grid operators to broadcast real-time pricing information and offer time-varying energy tariffs to customers to motivate them to consume power intelligently by charging them a higher price during high demand periods [3]. FANs/NANs must carry diverse data types and send control signals among utility companies and a great number of devices installed at customers' premises [3]. Hence, these applications need higher communication bandwidths (100 kbps to 10 Mbps) and coverage distances (up to 10 km) in comparison to HANs [3,8,48,53]. The communication requirements differ depending on the application type (field-based or customer-based). For example, low data rates (typically a couple of kbps) are required for meter reading applications, whereas higher data rates (tens or hundreds of kbps) are needed for advanced DA and ORM [49,59]. In addition, low-latency times are crucial for control and monitoring applications such as ORM, DA, and real-time monitoring [51,59]. NAN/FAN applications can be implemented over ZigBee, WiFi, Power Line Communication (PLC), as well as through long-distance wired and wireless technologies, such as WiMAX, Cellular, Digital Subscriber Line (DSL), and Coaxial Cable [8,47,57]. Still, the different requirements of NAN/FAN applications allow utilities to adopt separate communication networks for each applications class [59]. Table 2 summarizes the network requirements of the FAN/NAN applications in terms of latency and communications bandwidths.

4.1.3. Wide-Area Networks (WANs)

A WAN is the backbone of the communication network that handles long-distance data transmission and supports advanced monitoring and sensing applications [16]. It is a high-bandwidth network that provides a two-way communication channel between generation, transmission, and distribution systems and their different parts including PMUs, protection systems, and compensation equipment, among others [48]. Real time measurements of remote substations and consumers are transported to the control centers through the WAN [53,59]. At the same time, the WAN transfers control signals from the control centers to the electric devices [59].

The applications that can be supported by WANs include monitoring, control, and protection functions [8]. Compared to conventional SCADA systems, these applications need higher data rates and data resolution [48]. Applications like wide-area situational awareness require real-time data; others like substation automation, require high bandwidth and fast response times [50,51,61,62]. Compared to conventional

SCADA and energy management systems (EMS), a WAN allows shorter response times and higher data resolution (60 samples per second). A WAN requires high bandwidth to dispatch data from backhaul network to main control center. The communication infrastructure at this level must support transmitting high data rates, ranging from 10 Mbps to 1 Gbps, over long-distances coverage (up to 100 km) [8,47,48]. Among the communication technologies suitable for WAN applications are PLC, fiber optic communication, cellular networks, or WiMAX [3,6,8,47,48,51]. Although PLC and fiber optics provide secure and efficient data transfers, most utility vendors preferred cellular technologies for the WAN as they are fast and efficient [53]. Satellite communication is also used for providing redundant communication and backup at critical transmission/distribution substations, as well as for remote locations [47,57]. Table 3 summarizes the communication requirements for some WAN applications.

4.2. Impact of delays on power system stability

A major issue that needs to be addressed when developing communication-based monitoring, control, and protection systems in Cyber-physical power systems (CPPS) is the impact of time delays resulting from the communication infrastructure [63]. These delays are unavoidable whether the considered system is of a small-scale (e.g., Microgrid-level monitoring and control) or large-scale (e.g., wide-area monitoring and control). The time-delays observed in such systems are non-homogeneous and time-varying [29,64,65], and might span from tens to hundreds of milliseconds in real systems [64,66]. The time-delay values in a CPPS dictate the type of phenomena that can be monitored and controlled. Thus, if the communication-based monitoring and control algorithms are not designed considering the impact of time delays, their performance might degrade and can lead to adverse effects on the stability of the system.

The effects of time delays on stability have been carefully investigated in several engineering applications, such as signal processing and circuit design [67,68]. Conventionally, delays were not considered an issue in power systems except for the modeling of long transmission lines [69]. Wide-area measurements and the recent application of Phasor Measurement Unit (PMU) devices make remote measurements necessary, which has led researchers to investigate the effects of measurement delays. For this reason, in recent years, the effects of time delays on power system stability has been studied by means of the small signal stability of DDAEs in [29,70,71]. The effects of delays on small signal stability due to PMU measurements are studied in [72], based on a probabilistic approach. At the same time, there is the need to improve the robustness of controllers that are affected by time delays. Tens of milliseconds of time delay may cause the instability of communication-based controllers; for instance, in systems that experience wide-area oscillations with frequencies over 3–4 Hz, a 50 ms time delay on the Wide-Area Damping Controllers (WADC) means 90° phase lag for a 5 Hz mode [64]. To address these issues, [73,74] present a robust control scheme, considering the effect of time delays, for wide-area Power System Stabilizers (PSSs), and [75] proposes a delay compensation approach. Finally, [33] shows how to exploit delays to improve the stability region of existing wide-area controllers.

To demonstrate in practical terms the effects of different delays on monitoring and control of devices, Section 8.2 implements study cases showcasing different types of impacts that latency and other communication delays can have on the operation of a large number of devices.

5. Handling granularity in distribution and transmission systems

The large-scale integration of granular Distributed Energy Resources (DERs) and Flexible Loads (FLs) in modern power systems leads to the requirement for analyzing their impact on the overall power system behavior at the macro level. While these units are mostly located in

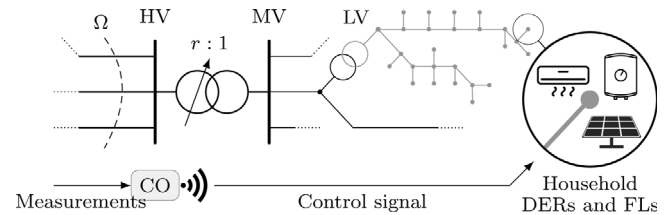

Fig. 4. Micro-to-macro interactions of granular DERs and FLs [76].

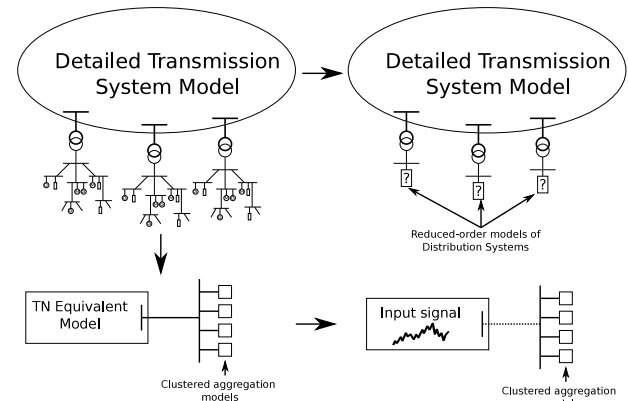

Fig. 5. Frameworks for assessing the impact of granular DERs.

low- and medium-voltage Distribution Networks (DNs), their aggregate response can significantly affect the bulk transmission system — whether it is their static or dynamic response and its impact on the security of the system, or their active participation to the system operation. These requirements give rise to several challenges related to the modeling, analysis, and coordination of Transmission and Distribution (T&D) operations. In this section, we investigate some of the key aspects related to T&D interactions when considering granularity at different voltage levels.

One of the main challenges relates to the modeling requirements when analyzing the micro-to-macro interactions of granular DERs and FLs, as shown in Fig. 4. When examining the entire power system, these granular units can easily count to thousands or hundreds of thousands. Moreover, most of them are located in thousands of low-voltage and medium-voltage distribution networks. To accurately capture the behavior of the T&D system, a detailed model would lead to networks with tens or hundreds of thousands nodes and thousands of units with detailed modeling and control (e.g., see Section 2.1). Whether it is for static analysis, dynamic analysis, or operational planning, such detailed models are often intractable and hard to analyze. For instance, in the case of dynamic analysis this would lead to hundreds of thousands of HDAEs; while, in the case of operational planning problems, they lead to non-convex optimization problems with hundreds of thousands of variables.

5.1. Aggregated and equivalent models

Traditionally, the analysis of the T&D interactions has been performed with the use of aggregate models and equivalent control laws to alleviate the dimensionality problem of analyzing combined T&D systems. Thus, when considering a single family of units or units with similar characteristics, an aggregated model is derived that models their collective response [77]. Such models are hard to derive due to the non-homogeneous unit parameters, their discrete response, and their stochastic nature. Thus, methodologies are derived to reflect their averaged continuous and expected response [78].

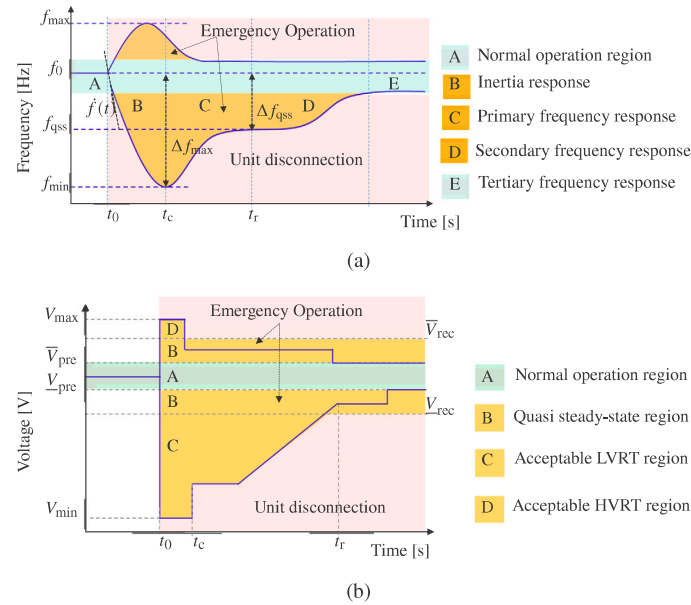

Fig. 6. Example of DER support regions with grid fault occurring at t_0 : (a) Frequency Ride Through (FRT) and (b) Voltage Ride Through (VRT).

In some cases, the performance of the aggregated models is analyzed in an open-loop manner by supplying the model with time-series data input from real measurements or simulated system responses [78]. This approach implicitly assumes that the behavior of the aggregated models has negligible effect on the bulk system response. However, in cases where the aggregated model response is significant enough to impact the behavior of the bulk system, then the performance must be assessed in a closed-loop manner using an equivalent Transmission Network (TN) model. These two approaches are shown in the lower panel of Fig. 5.

Either with the use of the open-loop or closed-loop analysis, this aggregated/equivalent modeling approach is the most computationally efficient. For each family of granular units, only a single aggregate model is used thus reducing the model from hundreds of thousands to few states. However, there are several challenges with these types of models.

First, since the aggregated models represent thousands of individual units, potentially spread over a large geographical span, the model cannot rely on local inputs. Thus, these models are frequently used to analyze the interactions concerning energy management or frequency response, which can be considered a global feature and common to all the granular units, but not voltage-related services, which rely on local features at the terminals of each unit. Moreover, this issue makes it impossible to consider geographical localization in the equivalent control laws of the aggregated models.

Second, these aggregated models disregard the network-related security constraints. Thus, they implicitly assume that there are no issues concerning line/transformer congestion and over-/under-voltage violations over the area they aggregate. Only internal constraints related to the type of units aggregated are considered (e.g. maximum power output of the devices, ramp rates, etc.). This can lead to optimistic estimation of the aggregated model response or, in practical implementations, violation of the system security limits.

Finally, with aggregated models, the impact of grid-code requirements on individual units is ignored. As explained in [79], depending on the location of each unit, the type of the event, and the initial conditions, individual units might violate these requirements and modify their behavior or disconnect from the grid. The lack of proper and accurate modeling of these requirements at an individual unit can lead to erroneous results. However, the overall response of the aggregate model usually assumes that none of these requirements is violated and

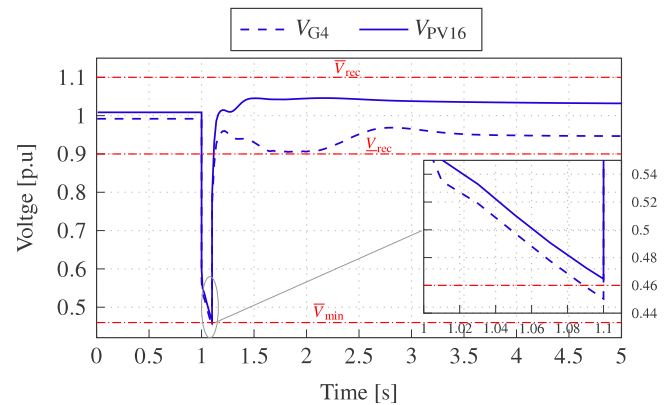

Fig. 7. Voltage at two different DER terminals compared to VRT requirements.

provides an optimistic output. An example of these requirements, depicted in Fig. 6, are the Voltage and Frequency Ride Through (V/FRT). Fig. 7 shows an example of voltage evolution after a fault [76] on two different DER nodes within the same distribution network. It can be seen that one of the units violates the VRT requirements, thus would be disconnected from the grid, while the other does not violate the requirements and would stay connected. This behavior cannot be captured with aggregated models. The technical report [80] highlights the importance of modeling the grid-code requirements and protections when analyzing the impact of DERs on the bulk transmission system (also summarized in Table II of [79]).

An alternative approach to the aggregated models is the use of reduced-order DN equivalents. In this case, instead of aggregating similar units spanning over different voltage levels and geographical locations, individual distribution networks along with all their DERs, flexible loads, and centralized or decentralized controls are reduced to smaller equivalent models [81–87] and attached to the detailed TN model (see Fig. 5, upper-right). This approach alleviates some problems of aggregated models. First, it allows to keep the complete TN model and maintain some degree of the localized response of the equivalenced units. Moreover, some of the proposed equivalencing methods (e.g., [83,87]) allow to model the network response, which is not the case for aggregated models. When a detailed model of

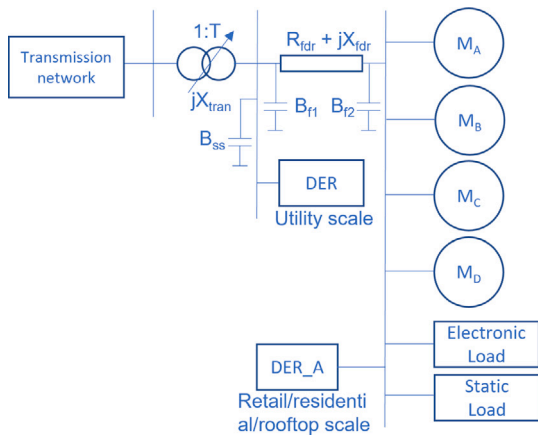

Fig. 8. Composite load model structure with equivalent motor load and distributed energy resource representation.

the DN is available, the stochastic nature of the DERs and Flexible Loads (FLs) is usually handled through Monte-Carlo simulations [85] to generate artificial measurements and extract the averaged expected model behavior. On the other hand, when a model of the DN and its DERs and FLs is not available, measurement-based equivalencing methods can be used [84,88–90] that make use of machine-learning methods to extract an equivalent model.

Nevertheless, some of the problems in aggregated models are also present in DN equivalents. More specifically, these equivalent DNs also fail to accurately capture the individual response of DERs and FLs based on grid-code requirements and protections [79,91] as well as the network-related constraints. Some of the proposed methodologies manage to extract the aggregate behavior of units against some of these requirements, for instance [85] captures the behavior against VRT requirements. However, due to the dependence of these requirements on local measurements and the non-linear behavior of the network and DER models, it is likely impossible to capture all of them.

5.2. Parameterization of aggregated and equivalent models

In industry applications, equivalent models of DNs are generally utilized to study their impact on transmission systems. In these studies, when using an equivalent model for a particular power flow operation snapshot, it is implicitly assumed that the underlying DN has the required hosting capacity to allow for the required distributed energy [92–97]. It is also assumed that the transmission planner has carried out a study to ensure that the corresponding level of distributed energy resources can be hosted on the TN [98,99].

With transmission system planning carried out at the transmission system operator level, the transmission planner has limited to no observability of the locations and types of distribution connected inverters. If measurement data is available, it may be possible to generate and parameterize a DN equivalent as mentioned previously in this section. However, these data, especially event-based data, are often hard to obtain. In Section 6, we discuss further the strengths and shortcomings of the model-based versus data-driven modeling and control approaches. We suggest that approaches which can combine the strengths of physics-based and data-driven modeling (e.g. grey-box models, physics informed machine learning) can offer the most value to future users.

Industry wide, there is an immediate need to be able to parameterize an equivalent model of the DN to allow the transmission system planning department to have some visibility of the expected performance from distributed energy resources. An approach that has recently been adopted by industry is the use of equivalent models such as

DER_A [100–102] to represent the behavior of the distributed energy resources, from both a voltage and frequency support perspective, and also a voltage trip perspective. Further, this model is represented alongside a combination of motor and static load models in a composite load model as shown in Fig. 8 [103–105]. In the following paragraphs, we show how to extract the equivalent model of a distribution feeder.

5.2.1. Extracting the equivalent model of a distribution feeder – a practical example

To allow for efficient transmission network studies, the distribution system network topology representation in this equivalent composite load model is kept to a minimal. Only the substation load step-down transformer and equivalent feeder impedance are typically represented. Phase shift in the transformer should be considered and can usually be obtained from feeder data. Alternatively, a 30-degree phase difference between its primary and secondary windings to account for a commonly used delta-wye connection is also an appropriate assumption. The MVA base and impedance of the transformers can also be obtained from feeder specifications.

To evaluate the value of the equivalent feeder resistance and reactance ($R_{fdr} + jX_{fdr}$ in Fig. 8) an example from [106] can be illustrative. Taking the IEEE 8500 node feeder as an example [107], the MVA base of the transformer is 27.5 MVA while the reactance is 15.51% on its MVA base. When converted to the 100 MVA system base, the reactance of the transformer is $0.15 \cdot 100/27.5 = 0.5455$ pu. Values of resistance and reactance of the equivalent feeder for positive sequence simulation are calculated by approximating losses in the entire feeder. The base topology of the feeder (without any distributed energy resources) has an electrical loss of 1.21 MW and 2.77 Mvar. Additionally, power supplied by the substation at 1.05 pu voltage is 11.98 MW and 1.38 Mvar. Assuming that the substation voltage is the reference voltage, current supplied by the substation can be calculated in per unit as,

$$\bar{I} = \frac{\bar{S}^*}{\bar{V}^*} = \frac{P - jQ}{V \angle 0} = 0.11486 \angle -6.571^\circ. \quad (2)$$

With this value of current, feeder resistance and reactance can be approximately calculated such that losses are maintained. The resultant value of resistance and reactance can be approximately calculated as,

$$R_{fdr} = \frac{P_{loss}}{I^2} = 0.91716 \text{ pu}, \quad (3)$$

$$X_{fdr} = \frac{Q_{loss}}{I^2} = 2.0996 \text{ pu}.$$

If the exact value of losses is not known, then with active power loss roughly estimated as 5%–10% of the feeder loading when distributed energy resource active power output is close to zero, feeder resistance can be approximately determined. Subsequently, feeder reactance can be obtained. Taking the same IEEE 8500 node feeder as an example, this calculation can be approximated as,

$$I \angle \phi = \frac{V_{substation} \angle 0 - V_{end} \angle \theta}{R_{fdr} + jX_{fdr}}, \quad (4)$$

$$\Rightarrow 0.11486 \angle -6.571^\circ = \frac{1.05 \angle 0 - 0.95 \angle \theta}{0.91716 + j2.0996}.$$

Here, the value of V_{end} is obtained either from the voltage profile of the feeder if available, or an estimate of the voltage drop across the feeder. Usually, voltage drop in an urban feeder in North America is around 0.02–0.05 pu while voltage drop in a rural feeder in North America is around 0.08–0.1 pu [108]. Voltage drop for feeders serving residential load can be assumed to be closer to the lower boundary of the range while voltage drop for commercial load can be assumed to be closer to the upper boundary.

Solving the equation above results in $X_{fdr} = 2.37$ pu, which also includes some portion of reactive power load along the feeder. From these calculated values, final values of resistance and reactance of the equivalent feeder are obtained by subtracting transformer resistance and reactance. The active and reactive part of the gross load to be placed at the end of this equivalent feeder is subsequently obtained by subtracting the losses from the power supplied by the substation.

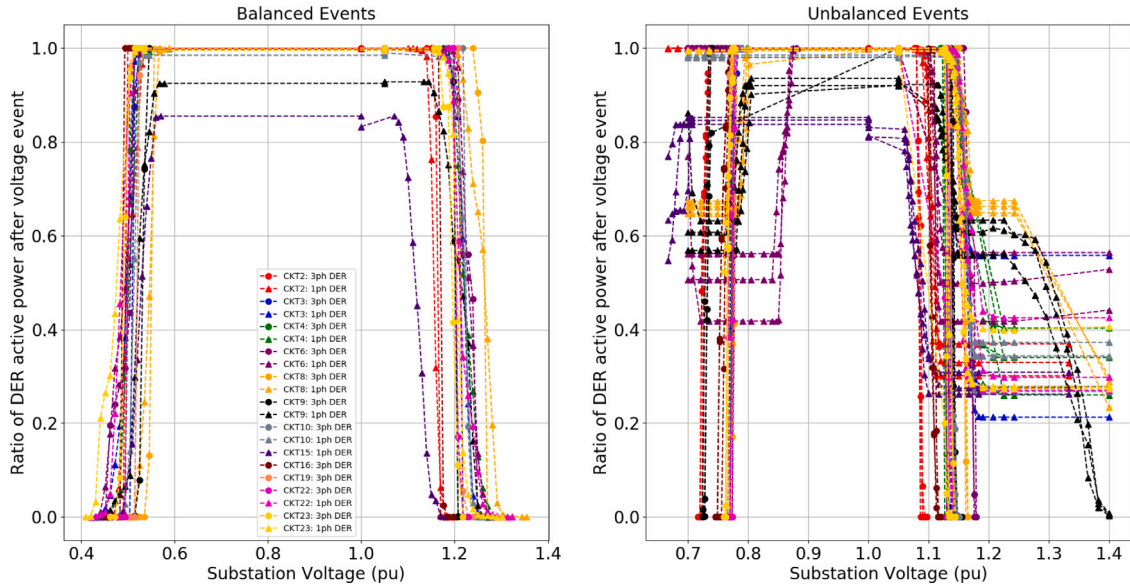

Fig. 9. Trip profile of distributed energy resources across multiple feeders with 100% distributed energy resource penetration with respect to load [108].

5.2.2. Additional considerations

In addition to obtaining the representation of the feeder, it is also important to parameterize the equivalent model sufficiently, both from load and distributed energy resource perspective. Guidelines for parameterization of the load component are detailed in [103] while guidelines for parameterization of the DER_A model are detailed in [108]. An example result from [108] is shown in Fig. 9 where the voltage trip profile of distributed energy resources across multiple feeders for transmission system fault events is evaluated using detailed distribution level studies. From these results, it can be seen that general trip profile parameters for the DER_A model can be constructed.

While most studies for representing and parameterizing distribution system equivalents consider only 3- ϕ balanced voltage sags and balanced loading, in reality, 1- ϕ events are more common on the transmission system rather than 3- ϕ events. Further, as most distribution system feeders in North America are connected to the transmission system through a Δ -Y-grounded step down transformer, a 1- ϕ event on the transmission system (Δ side of the transformer), will affect two phases on the distribution system and can thus cause a larger percentage of distributed energy resources to trip, as compared to the percentage of these resources that would trip for the same positive sequence voltage level corresponding to a 3- ϕ event. While this is the practical behavior of the system, transmission system planning is usually carried out in positive sequence domain. Thus, the challenge is to consider if the positive sequence equivalent model can represent the behavior of the distribution connected inverters even for 1- ϕ events. Ref. [109] lays out a process to achieve this equivalent model.

Studies carried out in [110–112] showcase that voltage has a much larger variation within a distribution feeder as compared to frequency. Even with a large percentage of distributed energy resources (both inverter based and machine based) and induction motor load in a distribution feeder, variation in frequency at individual nodes of the feeder are minimal. As a result, for transmission system analysis, it may be sufficient for distribution equivalent models to only have partial linear voltage based trip characteristics and have a complementary step based frequency trip characteristic.

5.3. Impact of tripping parameterization in aggregated models

The importance of accurately parameterizing tripping functions in aggregated representation of distribution equivalents with active power sources can be illustrated using a case study from [113]. Consider a large electric network with around 70 GW of load. For this example,

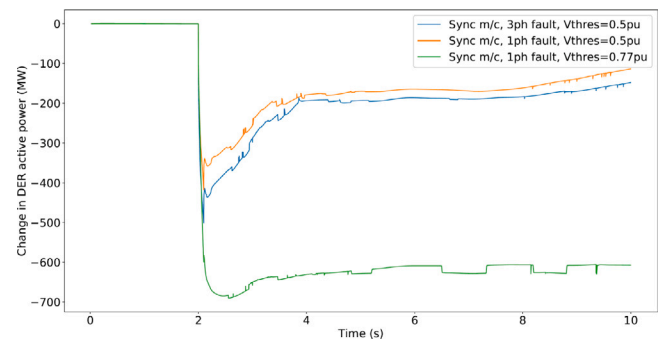

Fig. 10. DER impact on bulk power system fault behavior [113].

aggregated distribution equivalents are added to buses around the network such that 20% of the net load is served by distribution resources. The gross load is subsequently increased to maintain the power flow solution of the network. This amounts to around 14 GW of distributed energy resources represented by aggregated models.

The study is carried out with all machines represented by standard dynamic models and every load greater than 20 MW and lower than 40 MW is considered to be a standalone aggregated set of induction motor load. Loads greater than 40 MW are represented by the composite load model shown previously in Fig. 8. Distributed energy resources are also represented by an aggregated dynamic model. The voltage dependent trip characteristics of the aggregated distributed energy resources have to be parameterized appropriately in order to represent the trip behavior for both 3-phase and 1-phase faults. If the appropriate parameterization is not considered, then the observed impact on the system can be quite lower than what might actually occur.

In this system, for a normally cleared 3-phase fault, the impact on the system is nominal with only around 200 MW of distributed energy resources not being able to ride through as shown in Fig. 10. In this case, the authors in [113] have set the voltage trip threshold of the inverters at the distribution feeders to 0.5 pu for 0.16 s. However, with 1- ϕ faults being much more common, when a lot of generating resources are at the distribution level, 1- ϕ faults are more significant to study. Positive sequence simulation platforms though have limited capability to fully capture the impact of an unbalanced fault. When a 1- ϕ fault occurs on the transmission system, depending on the transformer winding configuration of the substation step down transformer,

the impact of this fault can be observed either on only the faulted phase (if transformer is Y-Y connected) or on two phases (if the transformer is Δ -Y connected). In both scenarios, a positive sequence equivalent voltage still has a magnitude that is larger than the actual faulted phase voltage [113]. As a result, a single phase fault can have a larger impact on the trip of distributed energy resource. Due to this, even though the individual distributed resources may have a trip threshold of 0.5 pu, the trip threshold in the aggregated positive sequence model has to be re-parameterized to a value of 0.7 pu, as derived in [113]. With this re-parameterization, it is seen that a single phase fault can cause a larger amount of trip of distributed resources, up to 600 MW (green curve in Fig. 10).

5.4. Full T&D models

The modeling problems described for the aggregated and equivalent models can be alleviated with the use of detailed T&D models that describe the TN and all of the DNs with all the dynamics, controls, and protections. In such systems, the individual response of the DERs and flexible loads along with all the grid-code and protection requirements can be modeled, thus capturing the localized response of the units and all the necessary network constraints. However, there are two main challenges in analyzing such combined T&D models. First, in many cases, due to privacy issues or simply unavailability of data, the models do not exist. Even if the HV and MV systems detailed models are available, detailed LV models are rarely available by system operators. Second, these combined systems can easily reach hundreds of thousands of HDAEs, making the analysis computationally challenging and requiring specialized software solutions.

The lack of real combined T&D systems to enable the accurate modeling and analysis of micro-to-macro interactions has led to the creation of synthetic T&D systems. While in the past several such systems were developed for single applications, recently open libraries with open synthetic systems have been introduced [114–116]. These systems provide combined LV, MV, and HV platforms with customizable characteristics (e.g., low-inertia, weak systems, high penetration, etc.) to analyze the performance of DERs and their impact on the TN. Moreover, they are open source, thus allowing for easier comparison between different methods without confidentiality or privacy issues.

It is probably obvious that the analysis of synthetic T&D systems, especially when considering the dynamic response of all DERs and flexible loads, is computationally intensive. Moreover, the modeling requirements for the LV and the MV/HV systems might be different due to often unbalanced operation of the LV grid. Thus, several methodologies have been proposed to simulate accurately and in a tractable way the combined systems [117–123]. Among them, methods that allow parallel computing and approaches for co-simulation seem to be promising. The emergence of quantum computing might also present benefits in the long term if approaches that can combine the strengths of classical computing with quantum computing are developed [124,125].

5.5. Trade-off between full T&D and equivalent models: An example

Full T&D models are accurate but introduce computational challenges. DN equivalent models are computationally efficient but they often raise the question if they capture all the necessary detail (the type of detail to be captured may differ for different use cases, and so do the types of DN equivalents). Using an example case study from [111], we explore the accuracy of positive sequence domain equivalent models. Our use case studies the impact of DER on the stalling and recovery of single phase induction motor loads. We show that special attention shall be paid to the accurate and sufficient parameterization of the equivalent model in order to have a similar behavior to the full model.

The positive sequence model used in the case study is an equivalent model shown in Fig. 8, whereas the electromagnetic transient (EMT) model is a detailed model of individual load/equipment with both transmission and distribution network represented in detail. The

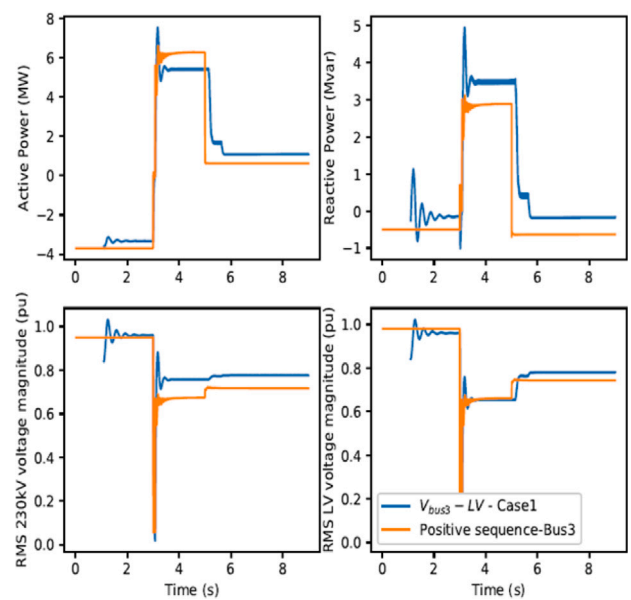

Fig. 11. For a transmission system fault, comparison of response from equivalent DN model at a transmission bus (orange curve) with the response from a detailed distribution feeder model connected at the same transmission bus (blue curve) [111].

equivalent model attempts to capture the aggregated response of all the underlying individual models that are distributed along the feeder. Therefore, the responses of the model can be more, or less, conservative depending on the underlying system that is being aggregated as well as the fault that is being studied. Furthermore, the equivalent model can be tuned to match the aggregated response of the detailed load within an acceptable margin of error using any least squares algorithm. These equivalent models are used for typical transmission planning studies where thousands of instances of such models are used. Since these will vastly outnumber models of power plants and other transmission devices, it is an industry practice to make sure that the equivalent model responses are neither too pessimistic nor too optimistic system wide.

Fig. 11 shows a comparison of response between the equivalent positive sequence model and detailed EMT model upon adding distributed energy resources to a feeder, with these resources having a momentary cessation threshold voltage of 0.88 pu. The event is the occurrence of a LLL-G fault on the transmission system along with the creation of a load pocket. Due to the distributed resources going into momentary cessation, and with the load pocket depressing transmission level voltages following the clearance of the fault, the distributed resources and single phase induction motors trip. However, even with such an impact to the system, it can be seen that the dynamic behavior from the positive sequence simulation with the equivalent model shows the same trend as the response observed from the detailed EMT simulation with full representation of the T&D network. In this situation, accurate and sufficient parameterization of the equivalent model is crucial as detailed in [110,111].

6. From physics-based to data-driven modeling and control

Traditionally, power system models have been based on first principles (i.e. based on physics and physical processes), which have often been parameterized through measurements. For example, parameters of the transformer models are often identified through short-circuit and open-circuit measurements. More recently, partially or purely data-driven models have emerged, where the modeling blocks do not necessarily correspond to a physical process. Data-driven modeling approaches become especially useful for components where the vendors

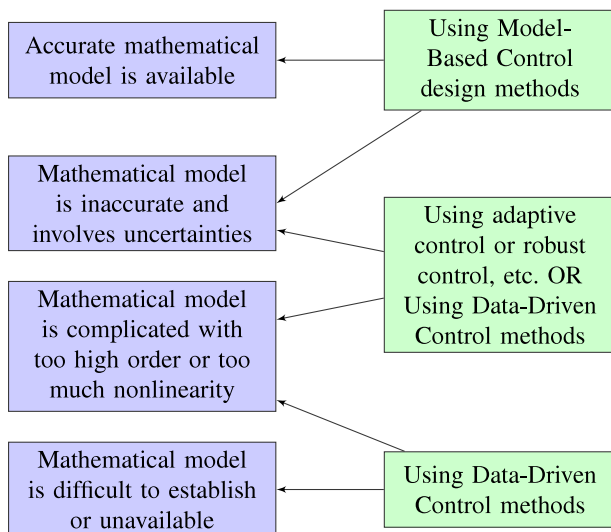

Fig. 12. Choice between model-based control and data-driven control [126].

supply only a black-box model of the component due to confidentiality issues.

Control design has been primarily based on Model-Based Control (MBC). In MBC, the first step involves building a model using first principles or identifying the model using data about the system or the component to be controlled. Then, a controller is designed using modern control theory, including both linear and nonlinear systems. Typical linear control system design methodologies include zero-pole assignment, LQR design, and others. For nonlinear systems, typical controller design methods include Lyapunov-based controller designs, non-linear model predictive control, back-stepping controller design, feedback linearization, and others.

As the systems get larger and more complex, the model error and uncertainty increases. Especially in modern power systems with multiple control layers starting from the low-voltage component level to the wide-area controls in large-scale systems, building accurate models required for MBC can prove extremely challenging. Considering also that some system or component models might be black-box (due to confidentiality or lack information), MBC can be impractical.

On the other hand, modern power systems generate and store huge amounts of process data at every time instant of every day, containing valuable state information of process operations and equipment. It is thus possible to employ Data-Driven Control (DDC) theory using these data, both on-line and off-line, to design controllers, predict and assess system states, evaluate performance, make decisions, or detect and diagnose faults. Besides rigorous data-driven control approaches, which include convergence and stability guarantees, an increasing amount of literature proposes approaches based on machine learning and reinforcing learning with promising results. Fig. 12 provides some insight about the benefits of using each of the methods depending on the availability of accurate mathematical models.

Overall, a combination of physics-based with data-driven approaches, both for modeling and control, appear to be the most promising for future applications. Physics-based modeling and model-based control are not only straightforward to interpret but also often come with convergence and stability guarantees. Both of these factors are crucial for their deployment in safety-critical systems, such as power systems. At the same time, the increasing complexity of power systems makes it often impossible to capture with sufficient accuracy all the relevant dynamics, especially when considering aggregate and equivalent models. In such cases, data-driven approaches can prove very effective. Therefore, the most promising approaches shall probably combine physics-based modeling with data-driven approaches, such

as grey-box modeling or physics-informed machine learning, among others [127,128].

7. The need for new tools

The massive deployment of inverter-based resources and the opportunities they offer for granular control will only be possible if new tools are in place to allow for the roll-out of advanced algorithms, including advanced communication networks, edge devices, and cloud computing.

7.1. Legacy systems

Legacy systems are expected to continue to operate as we transition to a new granular control paradigm. Therefore, new approaches should consider – and ideally integrate with – legacy communication and control systems.

In present day electricity networks, SCADA systems are used to monitor and control main electrical infrastructure at transmission level and provide early warning of potential critical situations that may threaten system stability. Their critical functions are data acquisition, supervisory control, and alarm display [129]. These systems usually entail one (or more) central host computer linked to a number of Remote Terminal Units (RTUs) and/or Programmable Logic Controllers (PLCs) located at key network busbars [129,130]. The RTUs collect local measurements from sensors and then send control commands to actuators [2]. They are programmed to report their measurements periodically (around every 2 s), to act as a data concentrator [131]. The central host computer processes the data collected and then displays the information in a comprehensible format to the operator [2]. This monitoring and control approach was designed to support control operations and interactions between control centers and field-based devices [2,131]. The main communication network of legacy systems was thus built using a hierarchical and centralized approach, in which the main requirement is to allow RTUs to send their measurements to a master RTU and then enable the master RTU to send commands to slave RTUs [2,131]. Interaction and communication between system operator and consumers is not considered in this scheme.

From a control perspective, the organization of power systems is based on a three-level hierarchical architecture which consists of generation, transmission, and distribution [132,133]. The resulting control scheme includes a huge array of controllers responsible for regulating different system quantities and designed according to the timescale of the phenomena to be controlled. However, most of these controllers are operated in a decentralized and uncoordinated fashion using local measurements only without having a global overview of the system state [1,133]. The main reason behind this control strategy is to reduce the communication requirements and allow fast response times [133]. Voltage regulators, PSS, and governors of SGs are all examples of decentralized controls where only a local output feedback is considered. Coordinated centralized control actions can be found for system balancing purposes, to coordinate some special protection schemes or actions between SGs in different system areas as well as in case of contingencies. Although the controllers of FACTS devices usually respond to local measurements as well, centralized set-point controls are also possible [133].

7.2. Need for the industrial IoT

The Internet of Things (IoT) describes the interfacing of an huge number of diverse devices and new technologies, far beyond what can be supported by the Internet (which has so far been the primary data sharing infrastructure). For example, the physical and communication infrastructure of lighting sensors, HVAC systems, manufacturing devices, and refrigerators, have been kept apart and compartmentalized

in individual systems. However, within the IoT framework, these applications can share the same infrastructure, giving rise to multiple benefits to their individual and collective use [134]. We observe a similar trend in industrial systems, where IoT is expected to allow for wide inter-operability and inter-connectivity between them. In practical terms, the IIoT is the framework that empowers the large-scale use of advanced solutions, upon which edge devices and cloud platforms are the de facto agents carrying out smart algorithms. A representation of electrical engineering applications is depicted in Fig. 13, wherein both edge devices and cloud platforms make use of the IIoT architecture.

With regard to power systems, the massive deployment of active consumers, Advanced Metering Infrastructure (AMI), EVs and other emerging devices at distribution level will push current monitoring and control approaches to their limits. The dimension and complexity of these electricity networks requires not only the adoption of more active and collaborative control approaches for ensuring system security [131], but also an enhancement of the whole communication infrastructure in terms of coverage and bandwidth capacity [2]. If applications like AMI or Energy Management Systems (EMS) are densely spread across distribution grids, the capacity of fast bidirectional communication among all devices and entities involved is paramount.

The communication channels should be able to support both much larger volumes of data supplied by diverse sources and two-way communication and interactions between far more actors than nowadays. Moreover, an active control approach requires many more grid measurements than those presently available, which entail a dense deployment of sensors as well [131]. However, main facilities in power systems so far are commonly monitored by a relatively low number of sensors installed at key grid busbars only. Finally, most of the field sensors employed use wired communication channels, thereby rendering their massive deployment impractical. Recent progresses made in low-cost, wireless sensing technologies could allow collecting fine granulated measurements in case of residential applications, where the reliability and delay requirements are low [2]. Note, however, that wireless solutions may fail in terms of customers security and privacy [135].

7.3. Need for edge devices

Edge devices are positioned at the edge of systems. In power electronics, an edge device naturally translates to a converter equipped with both telecommunication and local computing capability, often provided via standard microprocessors. Without edge devices, local controllers can only operate in an isolated and static manner, executing local pre-defined actions.

Three key factors make edge devices a major player in the IIoT. First, they enable centralized (higher-layer) control algorithms by providing relevant data [136]. This is a crucial step to bridge the gap of limited observability at low-voltage distribution grids. This data also becomes a powerful source for data-hungry intelligent applications – such as machine learning (ML) – and enables the development of advanced real-time tools. Second, edge devices enable a plethora of distributed algorithms, which present a strong alternative to the top-down hierarchy currently found among most power systems [137]. Third, edge devices offer a local data storage capacity allowing for local smart data management and data aggregation. Data aggregation techniques will be essential to reduce data overloads, especially during peak-traffic periods. While this would allow to better exploit limited bandwidths, at distribution level it can also increase the risk of exposing the privacy of consumers. At high voltage levels, on the other hand, data aggregation can allow operators to have information from the entire grid, albeit with reduced granularity of detail [2]. Finally, the substantial storage capacity and computing facilities that will be required for dealing with huge volumes of data will further benefit from smart management of data across devices, which creates a need for pre-selecting relevant data to be communicated and which data should simply be stored on the edge.

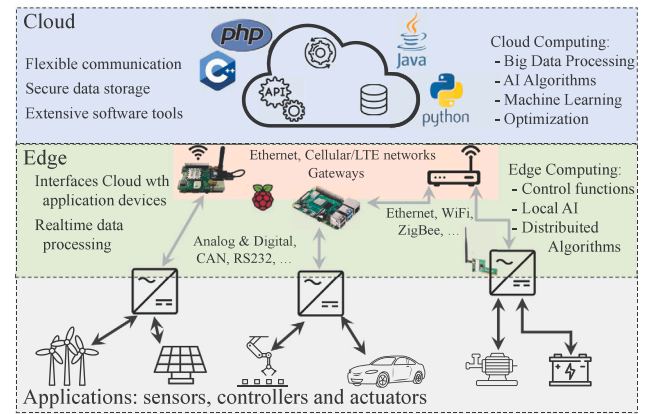

Fig. 13. A diagram depicting a generic arrangement with edge devices and different applications, interfacing with a cloud platform.

7.4. Need for cloud platforms

The other major agent in the IIoT framework are cloud platforms, which offer a virtual infrastructure that can establish connections to edge devices, software, databases, and third-party applications. They can also store data, and execute a multitude of algorithms, in parallel, to achieve multiple goals aligned with all different applications and stakeholders alike.

Even if cloud platforms are able to handle large amounts of data and make use of scalable algorithms, the communication latency between agents is generally above a few seconds; and it can only be reduced to as low as a few hundred milliseconds. Therefore, it is impossible to make use of local devices' dynamic and high-frequency measurements since such events are much faster than the latency across cloud platforms and edge devices. We can establish a clear distinction between (i) edge device that can execute distributed algorithms; and (ii) more complex algorithms deployed on cloud platforms, which instead account for RMS, steady-state values.

7.5. Need for improved analytical tools

A new fleet of analytical tools are required that can reduce the dependence on detailed simulation. Examples of such tools move e.g. along the lines of our discussion in Section 5. Detailed simulations are and will continue to be important for power system analysis, however they must be complemented through the use of analytical methods that can serve as screening criteria. This can help drastically reduce the computational complexity and time required for detailed simulations. These analytical tools have to be able to work with black box models, as several inverter resources contain proprietary control algorithms, and more importantly, work at multiple different operating points. Additionally, analytical methods that can cover both small signal and large signal stability constraints are to be further developed. These newer suite of tools have also to be capable of representing the behavior and impact of communication delays and loss of communication.

8. Case studies and applications

This section collects fundamental results of comparatively simple case studies. Our intention is to highlight through simulations the phenomena emerging through the granular control of large populations of devices – as discussed in the previous sections – and demonstrate the challenges that are currently open fields of research.

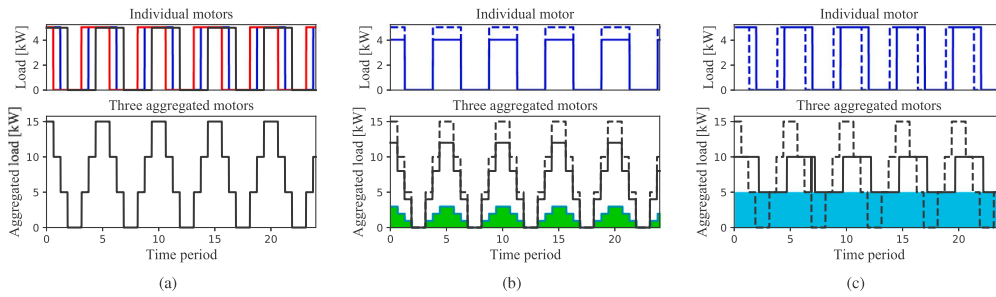

Fig. 14. Three applications with 5 kW aggregated in (a) a basic operation, (b) a power shift of 20% enabling a varying flexibility reserve across selected intervals, and (c) a time shift across all applications enabling a continuous flexibility reserve of 5 kW.

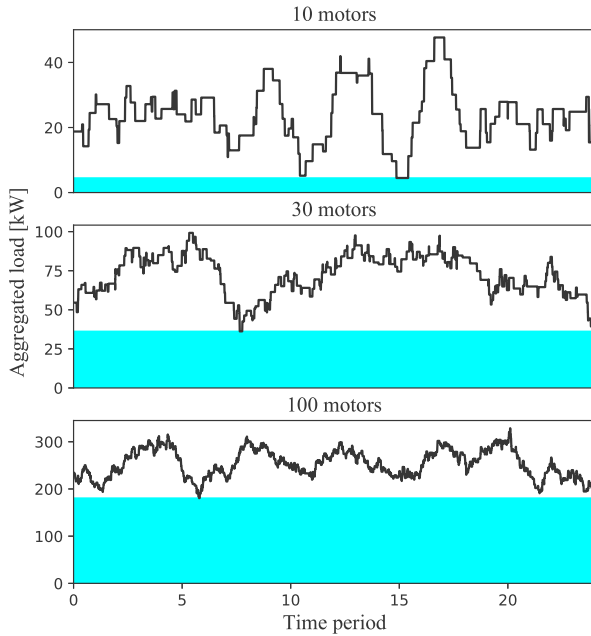

Fig. 15. Three different groups with aggregated loads under stochastic behavior. The devices have an average of 5 kW size, and size, duty-cycle, activation time and periodicity are randomly assigned according to normal distributions. The top panel demonstrates a situation where aggregation of ten motors provides less than 20% of the average power for continuous flexibility reserve. The middle panel shows an improved performance, with over 45% available flexibility. The bottom panel represents a higher flexibility available at any given time, with over 70% of the average load being available at any given time. The time periods are agnostic (i.e., may be applied to second-, minute- or hourly-level intervals).

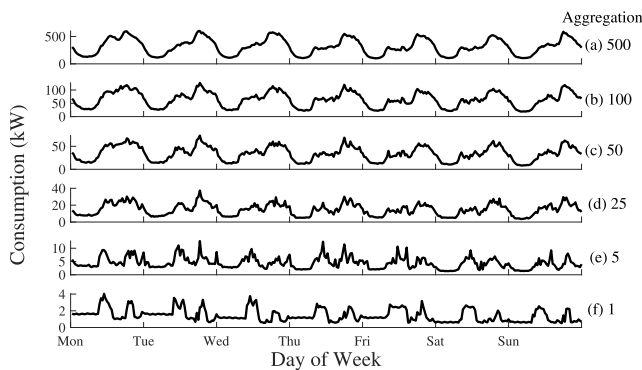

Fig. 16. Examples of a week's worth of demand from aggregations of 500 households (panel a) down to a single household (panel f) [138].

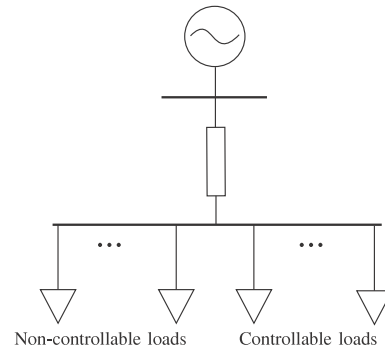

Fig. 17. Two-bus system used in simulations. Two groups of devices, non-controllable and controllable devices, are connected to the second bus, which is connected to a swing bus via a transmission line.

8.1. Modeling aggregation of micro devices

We first demonstrate how two basic factors affect the available flexibility of a population of loads: the synchronous or asynchronous operations of the loads, and the size of the population. Three devices, with a rating of 5 kW, are turned on and off in regular intervals with a 50% duty-cycle (on average), which can be seen in Fig. 14(a). Let us assume that during these intervals, the loads could have their power reduced by 20% for an indefinite amount of time, or could be entirely turned off for a short period of time. These are interesting applications for, respectively, secondary and primary frequency response, as previously shown in Fig. 6. Assuming the baseline consumption of Fig. 14(a), we observe that the aggregate load is not constant. Considering that every load is flexible and able to reduce its power by up to 20%, if we attempt to extract the aggregate baseline flexibility, as shown in Fig. 14(b), one obtains an inconsistent *varying flexibility reserve*. To extract most of the potential of aggregated devices, we need to shift their operation in time — assuming there is some flexibility in when they can turn on (further discussed in the below paragraph). By simply shifting one of the loads, as shown in Fig. 14(c), we achieve a baseline consumption, which can provide reliably a *continuous flexibility reserve* that can be used, e.g., for primary frequency response and a series of other purposes.

To become a reliable participant in providing key services to the grid, aggregated DERs need to achieve a *satisfactory reliability* across *stochastic operation*. Therefore, we extend the initial simulation idea to more devices and introduce randomness in their activation times. We assume that their duty-cycles, rated power, and periodicity are controlled by normal distributions. The behavior of ten devices in such a manner, as shown in the top panel of Fig. 15, indicates that there is not a good enough reliability to provide a baseline consumption — which is only natural. In this case, the baseline available flexibility is less than 20% of the average power. However, as we increase the number of loads to 30, as shown on the middle of Fig. 15, over 45%

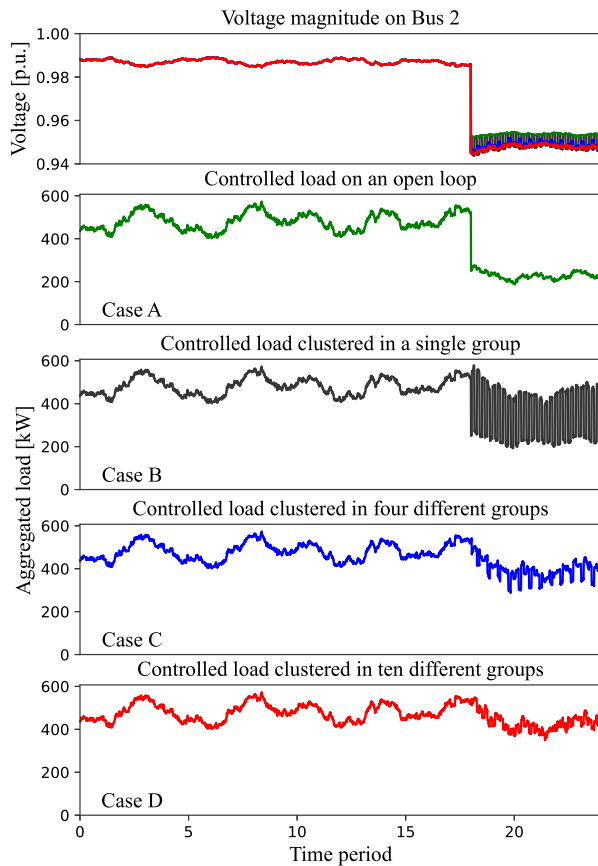

Fig. 18. A single plot of four cases' voltages (top panel) and each of their aggregated load responses (lower four panels). A fault located in the swing bus leads to the second bus to dip below the minimum 0.95 pu limit, which triggers controllable loads (half of the aggregated devices' load). Case A denotes the open-loop case, where controllable loads are not turned on again even after the voltage recovers above the minimum limit; Case B depicts a closed-loop response where all controllable loads act in the same time, leading to an oscillatory behavior; and Cases C and D demonstrate how aggregating devices in smaller clusters and introducing a delay for their activation reduces the oscillatory behavior witnessed in Case B. The time periods for the simulation are agnostic (i.e., may be applied to second-, minute- or hourly-level intervals).

of the average power is constantly turned on. This grows to over 70% when we consider one hundred loads, which points to a much more reliable operation of aggregated DER.

Aggregating randomly operating loads with similar behaviors can offer consistent flexibility to act as controllable devices that can play a central role in maintaining the stability of future power systems. In fact, a very similar effect has also been observed when looking at the electricity demand of real-world households, as shown in Fig. 16 [138]. Aggregating a small number of households presents some hard-to-predict behaviors, whereas a larger number of aggregated households has a much smoother and more predictable aggregated behavior.

8.2. System impact from aggregations of devices

We now extend the simulation to a simple two-bus scenario with inclusion of the aggregated models described in Section 8.1. This leads to create study cases that include several key aspects discussed throughout the paper, and to demonstrate in a simple and efficient way the challenges and characteristics of large-scale aggregation of controllable devices with stochastic nature.

The system is composed of a swing bus connected to a second bus via a transmission line. The second bus has loads connected directly to it, which is shown in Fig. 17. Two hundred devices (average size

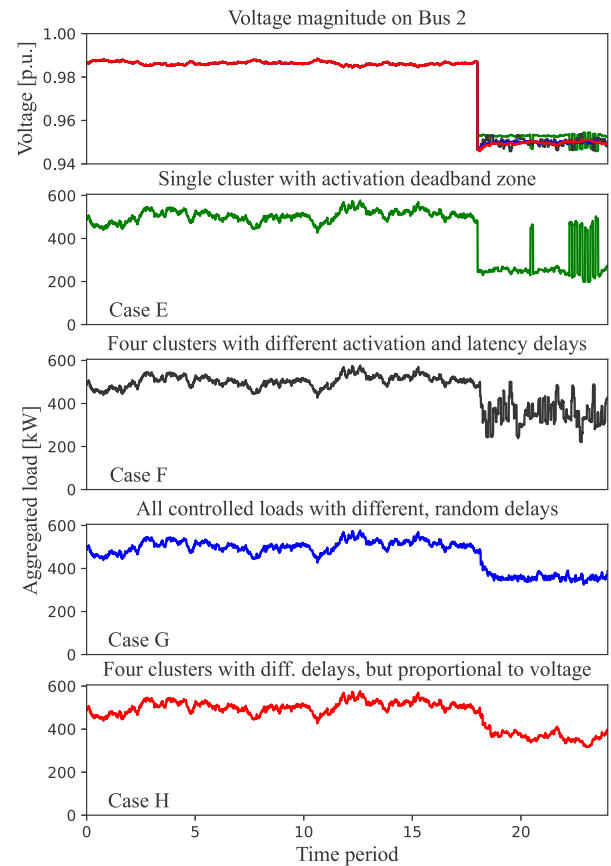

Fig. 19. A single plot of four cases' voltages (top panel) and each of their aggregated load responses (lower four panels). A fault located in the swing bus leads to the second bus to dip below the minimum 0.95 pu limit, which triggers controllable loads (half of the aggregated devices' load). Case E depicts the results for the same settings as Case B, but introducing a dead-band zone during which the loads are not turned back on. While it is more smooth than Case B, it is still prone for some periods with oscillatory behavior. Case F showcases the results for the same settings as Case C, but using different time delays for the activation of different groups, in which it is clearly visible that the devices respond in a very unstable manner. Case G assumes all controllable devices have different delays in activation or latency, which leads to a very smooth system-wide response, even if some minority of the loads might be activated too often. Finally, Case H depicts the results for a simulation with the same settings than Case F, but introducing a coordination scheme where some of the devices in each cluster are turned off, proportional to the local voltage. It depicts another very smooth response, but is the case that requires the most coordination among all cases showcased here. The time periods for the simulation are agnostic (i.e., may be applied to second-, minute- or hourly-level intervals).

of 5 kW) are connected to the second bus, where half of those are controllable devices and the other half have a non-controllable demand. They all have the discrete behavior presented in Section 8.1; the devices have, on average, a 50% duty cycle — and, as previously, their size, duty-cycle, activation time and periodicity are randomly assigned according to normal distributions, to better account for deviations in real-world scenarios.

We describe an agnostic approach that allows for the discussion of different characteristics while using the same system settings. Nevertheless, the same logic shown throughout most study cases can be applied to any time scale, for a variety of suitable ancillary services, using any activation settings.³ Let us assume that the controllable devices are set

³ The interested reader is referred to the first chapter of [139] for a clear description of different functions and their associated timescales in electrical engineering, including protection, generation control, economic dispatch, unit commitment, load forecasting, and others analyses.

to turn off when the voltage on the second bus dips below 0.95 pu. A fault occurs at the swing bus, at time period $\tau = 18$.⁴ This reduces the swing bus voltage, consequently causing a voltage drop on the second bus. The controllable devices respond by turning off; meanwhile, if the voltage on the second bus is restored above the 0.95 pu limit, controllable devices might turn on again. In both Figs. 18 and 19, the top plot depicts the voltage before and after the fault for four different cases; we elaborate on the four cases in the following paragraphs.

All cases have the same quantity of available device flexibility, as discussed in Section 8.1, but different cases will act according to particular settings. Such settings are categorized next, and will emphasize different behaviors, highlighting challenges and characteristics. Finally, it is worth noting that the time period used herein is agnostic, meaning it can be adjusted according to the desired end-application of the model and simulation at hand. This might range from very fast periods, in seconds, to minutes and hours.

8.2.0.1. Case A — Open-loop response. Case A demonstrates an open-loop approach to modeling controllable devices in a simulation environment. Fig. 18 shows that all controllable loads simply turn off after the fault, and the voltage is then restored to above 0.95 pu. On one hand, this allows the remainder of the loads to continue operating within the designed operating conditions. On the other hand, the final operating point is not known *a priori*, as it depends on the number of controllable devices currently connected to the grid and the severity of the contingency. If, as a consequence of the disconnection of the controllable devices, the voltage is restored close to its nominal value, then controllable loads will turn on again, thus leading to the flapping phenomenon. In the next cases, we discuss which closed-loop settings can be implemented, alongside their particular characteristics and potential challenges.

8.2.0.2. Case B — Loads clustered in a single group. The second study case demonstrates a naïve approach to implementing a closed-loop approach. First, let all devices be synchronized and respond within the same time frame. Second, assume they can all detect the fault at nearly the same moment, and respond accordingly. Third, let the devices control their load setting by turning off when their voltage is below 0.95 pu, and turning their load back on in case the voltage rises above 0.95 pu.

The third plot in Fig. 18 depicts the simulation result using the aforementioned settings. It is clear that the devices are responding as intended; however, because of the voltage level at which the system is, such response is not desirable. When all controllable devices respond to the fault by turning off, the voltage is restored to above 0.95 pu; as such, in the next control cycle, all loads turn back on; and in the following cycle, they turn off because turning all loads leads to a voltage below the limit. This is repeated endlessly (flapping) as long as the voltage remains within this *critical* voltage level, meaning the system will enter in this oscillatory behavior.

This phenomenon is known to happen under certain conditions in the control of different applications. A common example is PV inverters operating under a Volt-VAr control (VVC) response curve, which determines the reactive power injection to the grid according to the voltage at the inverter's point of common coupling. This control allows PV inverters to provide additional flexibility to the grid; however, the most simple VVC implementation relies on a droop control, which is known to replicate the same oscillatory behavior described for Case B here [140]. Similarly, this effect has been witnessed in the control of large wind power plants.

There are several approaches in the literature to tackle this effect. In the next paragraphs we describe control schemes that are based in the main underlying principles of these approaches, while highlighting additional characteristics or challenges.

⁴ Note that τ represents an arbitrary time unit. The results presented in this section assume that $\tau = 1$ corresponds to 1 s.

8.2.0.3. Case C — Loads clustered in four groups. The first approach to address the problem witnessed in Case B is to equally divide the group of one hundred controllable devices into four smaller groups. Each group acts in evenly spaced intervals, effectively setting the response of each group to 4× slower than the original demonstrated closed-loop response of Case B. Simulation results, shown in the fourth panel of Fig. 18, present a more well-behaved response when compared to Case B. Even if it is not entirely smooth, it shows improvement over the previous approach.

8.2.0.4. Case D — Loads clustered in ten groups. Next, we increase the number of clusters, from four to ten different groups of controllable devices. Consequently, we increase the response time for each individual group by 10×. The fifth panel of Fig. 18 depicts a better-behaved response when compared to Cases B and C, where less controllable devices are actuating in an oscillatory behavior. Note, however, that by further increasing the size of clusters, we are introducing artificial delays to the response time of the controllable devices. For certain applications, this might result in a response that is too slow. As described in Section 5, there might be protection relays and other fast-responding mechanisms which are set to trip within such time interval, effectively rendering the flexibility of the controllable devices to be obsolete under these conditions. This further highlights that there is no simple answer on how to setup a universal control strategy for devices — including the number of clusters, and beyond. Instead, these are challenges to be considered when simulating and implementing such aggregation of devices.

8.2.0.5. Case E — Single cluster with activation dead-band zone. Using a dead-band zone for triggering the controllable devices might partially solve the issue presented in Case A, as shown in Fig. 19. However, the size of the deadband requires careful tuning as it is system dependent. An alternative is to use data-driven approaches such as machine learning, as mentioned in Section 6, to acquire additional data which might complement the model. Nevertheless, both approaches are particularly difficult for weak low-voltage grids, since they typically have low observability and little data recording available.

Furthermore, even after a thoughtful planning, the oscillatory behavior might still occur, as shown near the end of the simulation, in Fig. 19 for all cases, including Case C and Case D, show in Fig. 18. As long as a considerable part of connected devices are controllable, their response to the system will be significant to such an extent that this behavior might be expected, according to any particular system's configuration.

8.2.0.6. Case F — Loads clustered in four groups with different delays. The same situation as Case C is simulated, where controllable devices are equally arranged in four groups with twenty-five loads each; however, in this case, each cluster responds at a different time. The logic behind this is that different groups of devices will have different characteristics in either activation or communication delays, according to their own particularities or communication network connection. This case study assumes there is one fast-responding cluster, with the same delay as used in Cases B-E, and the three other clusters have 3×, 4× and 5× as much delay. This accounts for different activation and latency delays; in real-world, it might be related to how fast a device is set to measure the grid voltage and react to it, or what is the latency on the communication link given the technology in use, as described throughout Section 4. The impact of delays in the operation of the system is also emphasized in Section 4.2. In the results shown in Fig. 19, the same oscillatory behavior witnessed in Case B clearly appears again. Even if it is only 1/4 of the controllable devices that act too quickly compared to Case B (all the rest react slower), they do create a noticeable oscillatory response that has a system-wide perspective.

8.2.0.7. Case G — All devices with random delays. Using the same logic as described in Case F, not only different clusters of devices might respond in a different manner and have different delays, but each device might intrinsically have a different activation time. As such, in this case, we assume that each device is assigned a random activation delay (or communication latency), which ranges between the original fast response of Cases B–D, and down to 20× slower than the fastest-activating device. The results shown in Fig. 19 indicate a much smoother system-wide response. The plot does show, however, that there might be a particular interval where the fastest-responding loads fall back into a state of oscillation. Even then, this is much less prominent than what is shown in Cases B and F. Yet, this poses a problem if there are loads which are sensitive to many rapid on-off cycles.

8.2.0.8. Case H — Response proportional to voltage. This last case considers an intelligent decision-making algorithm that correlates the response of each device to a grid signal. We pick the “worst-case scenario”, Case F, and create a proportional, linear voltage response around the interval from 0.94 to 0.96 pu, which correspond to none and all devices active, respectively. Even with the different activation and latency delays, we can see that the results for Case G in Fig. 19 present a very smooth function — in fact, the smoothest of all cases, and closely resemble a normal activity.

Case H is a good example of what is discussed throughout this work, in particular having in mind the existence of a communication network as described in Section 4, making use of intelligent coordination strategies and employing new tools for such coordination and actuation, as described in Section 7. It is relevant to note that any particular device within each cluster might be subject to different characteristics, as mentioned in Section 2, but in general, the system-wide response for such coordinated system can provide a more precise control over the available flexibility offered by DERs.

8.3. Modeling of micro devices with periodic duty-cycle

This section presents an example of how we can move from the detailed modeling of a single device to an ideal aggregated model of several devices, and how this model compares with a real-world equivalent. In this example, we describe a class of micro electrical devices, namely Thermostatically Controlled Loads (TCLs), that are well behaved and can be aggregated into a quasi-deterministic model when uncontrolled.

In recent years, TCLs have been the focus of a variety of research works because of their potential to regulate the frequency while keeping the temperature within a given range [141–145]. The modeling of such devices has thus become relevant for transient stability analysis.

Refrigerators, heat pumps, HVACs, bitument tanks, water heater devices are all examples of TCLs. While models of individual TCLs for each technology are well-known, and have a relatively simple implementation — typically a first order ordinary differential equation. the main difficulty of studying the effect of these devices in a distribution or transmission system relies in that one needs to simulate a large number of them. This can have a significant impact on the computational burden of the simulations. It would be desirable, for simulation purposes, to have a systematic approach to present an aggregated model of TCLs that is independent from the technology.

While TCLs are based on different technologies and have different purposes, they all operate between two given threshold temperatures, say T_{\min} and T_{\max} . In case of cooling devices, if the temperature of the device reaches T_{\min} , the load will switch off while if temperature of device reaches T_{\max} , the load will switch on. For heating devices, the switching logic is the other way around.

In this section we first describe the dynamic model on an individual TCL. Then we propose an ideal aggregated model of TCLs. Finally, we discuss how the ideal model resembles in a real-world scenario.

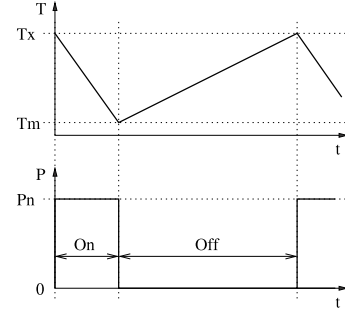

Fig. 20. Temperature and power cycles of a typical refrigerator.

8.3.0.1. Model of a single TCL. A linear first order differential equation can be used to model the dynamic behavior of the temperature $T_i(t)$ of the i th TCL, as follows [143,146]:

$$\dot{T}_i(t) = \frac{1}{RC} [T_s - T_i(t)] \pm \frac{\eta}{C} P_i(t) \pm \xi_i(t) \quad (5)$$

$$P_i(t) = u_{i,t} P_{n,i}, \quad (6)$$

where R and C are the thermal resistance and capacitance of the load, respectively; T_s is the surrounding temperature; η is the coefficient of performance; $P_{n,i}$ is the nominal power; and ξ_i is a noise term which includes the effect of disturbances. For example, in case of refrigerators, ξ_i models events such as door openings, change of food content, etc. $u_{i,t}$ is the state of the i th TCLs and its value is either 1 or 0 depending on whether TCL is on or off. The control of the TCL turns it on when $T_i > T_{\max}$ and turns it off when $T_i < T_{\min}$. The temperature and the power cycles of a typical TCL are shown in Fig. 20. Assuming that the time during which the TCL is on and off are t_{on} and t_{off} , respectively, the duty cycle is defined as:

$$d = \frac{t_{\text{on}}}{t_{\text{on}} + t_{\text{off}}} = \frac{t_{\text{on}}}{t_c}, \quad (7)$$

where t_c is the period of the cycle. In the following, we will assume that $d \leq 50\%$, i.e., $t_{\text{off}} \geq t_{\text{on}}$, which is always satisfied for TCLs.

The TCL model (5)–(6) can be straightforwardly implemented in any software tool for power system analysis. However, their small size and large number makes such devices quite cumbersome for transient stability studies. In the following subsection, we propose an ideal aggregated model that retains accuracy while having a negligible computational burden.

8.3.0.2. Ideal aggregated model. Let us consider the ideal case in which we have N TCLs of the same type. Let us also assume that at $t = 0$ all devices are off, and that for $0 \leq t \leq t_{\text{off}}$, the devices switch on one at a time at equally spaced intervals $\frac{t_{\text{off}}}{N}$. If N is sufficiently high, we can treat the cluster of TCLs as a *continuum*. Then the total power P_T that the cluster of TCLs is consuming at any given time t is given by:

$$P_T(t) = N P_{n,i} \cdot \begin{cases} \frac{t}{t_{\text{off}}}, & \text{if } 0 \leq t < t_{\text{on}} \\ \frac{t_{\text{on}}}{t_{\text{off}}}, & \text{if } t_{\text{on}} \leq t < t_{\text{off}} \\ \frac{t_c - t}{t_{\text{off}}}, & \text{if } t_{\text{off}} \leq t < t_c. \end{cases} \quad (8)$$

8.3.0.3. Real-world aggregated model. Since in practice TCLs have randomly distributed phase shifts, we now remove the hypotheses that the devices switch on at equally-spaced time intervals. With this aim, let us first observe that the sum of N sinusoidal signals with same frequency and random phase shift is still a sinusoidal signal with same frequency as the original components:

$$\sum_i^N \sin(t + \phi_i) = \sin(t) \sum_i^N \cos(\phi_i) + \cos(t) \sum_i^N \sin(\phi_i) \quad (9)$$

$$= A \sin(t + \phi),$$

where ϕ_i are uniformly distributed in the range $[0, 2\pi]$; and $A = \sqrt{s^2 + c^2}$ and $\phi = \sin^{-1}(s/A)$ with $s = \sum_i^N \sin(\phi_i)$ and $c = \sum_i^N \cos(\phi_i)$.

Then, since the time evolution of the power of each TCL is a rectangular wave, we can rewrite (6) as a Fourier series, as follows:

$$P_i(t) = d P_{n,i} + \frac{P_{n,i}}{k\pi} \sum_k^{\infty} [a_k \sin(\omega_k t) + b_k \cos(\omega_k t)], \quad (10)$$

where $\omega_k = \frac{2\pi k}{t_c}$, $a_k = \sin(2\pi k d)$, and $b_k = 1 - \cos(2\pi k d)$.

Eq. (10) is written assuming that the load switches on at $t = 0$ and off at $t = t_{\text{on}}$. In general, the phase shifts ϕ_i of the TCLs will be uniformly distributed in the range $[0, 2\pi]$. Thus, considering (9), the sum of the N power consumptions of the TCLs:

$$\begin{aligned} P_T(t) &= N d P_{n,i} + \frac{P_{n,i}}{k\pi} \sum_k^{\infty} \sum_i^N [a_{k,i} \sin(\omega_k t) + b_{k,i} \cos(\omega_k t)] \\ &= N d P_{n,i} + \frac{P_{n,i}}{k\pi} \sum_k^{\infty} A_k [a_k \sin(\omega_k t + \phi_k) + b_k \cos(\omega_k t + \phi_k)], \end{aligned} \quad (11)$$

where $A_k = \sqrt{s_k^2 + c_k^2}$, $\phi_k = \sin^{-1}(s_k/A_k)$, $s_k = \sum_i^N \sin(k\phi_i)$, and $c_k = \sum_i^N \cos(k\phi_i)$.

We note that (11) has the same structure of (10) except for the phase shifts ϕ_k . Moreover, (11) tends to (8) as N increases. This can be deduced from the fact that, as N increases, the average time interval, say \bar{t} , after which a TCL switches on tends to the ideal model, i.e., $\bar{t} \approx \frac{t_{\text{off}}}{N}$, for N sufficiently high. The equivalence between (11) and (8) is illustrated in the following section.

An argument on the effectiveness of the model presented so far is that, as soon as random events, such as the action of opening the door of a refrigerator, are included in the model, its periodic behavior would be lost. The effect of these events, however, does not seem to be crucial when compared to the long-term dynamics of the temperature. In particular the marginal impact of the opening of the doors is discussed in detail, for example, in [143].

8.3.0.4. Examples. Let us consider two numerical examples of the ideal and real-world aggregated models of TCLs for two specific technologies, the refrigerator and the heat pump. For the sake of simplicity, but without loss of generality, we assume that, for each load type, the period t_c , duty cycle d and nominal power $P_{n,i}$ are the same for each individual device. We also assume that T_s is constant and $\xi_i = 0$.

Refrigerator: Let us assume that each refrigerator is characterized by $t_{\text{on}} = 810$ s and $t_{\text{off}} = 3340$ s, thus leading to a duty cycle of $d = 19.51\%$. The parameters of the refrigerators considered in this example can be found in [143]. Fig. 21 shows the time evolution of the active power of 1000 refrigerators, considering both the proposed ideal and real-world models. As expected, the both aggregated models have same shape and period. The real-world model shows a deviation with respect to the ideal one of, at most, 2.5% of the total power. Such a deviation is due to the fact that the number N of refrigerators is finite and can be easily included in the ideal model by adding noise.

Heat Pump: Fig. 22 shows the transient behavior of the active power of 1000 heat pumps with duty cycle of $d = 50\%$ [145], which confirms the match between the ideal and the real-world models. We note that the shape of (8) and (11) depends exclusively on the duty cycle d . The amplitude, on the other hand, is a function of the duty cycle d , the nominal power of each device $P_{n,i}$, and the total number of devices N .

8.4. Impact of granularity on stochastic control

In this example, we show the impact of time and power granularity on the demand-side response of loads, increasing the level of modeling detail compared to Section 8.2 in order to showcase how we can derive more realistic models and examine their results.

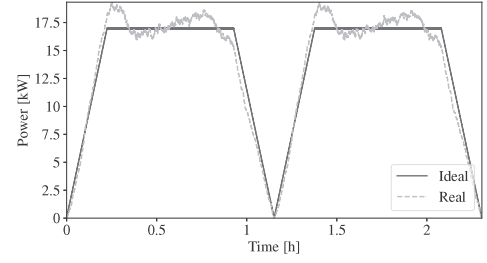

Fig. 21. Total active power consumption of 1000 refrigerators with $d = 19.21\%$.

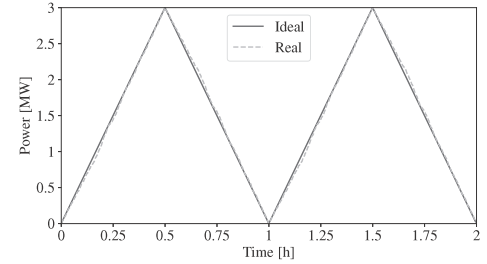

Fig. 22. Total active power consumption of 1000 heat pumps with $d = 50\%$.

The controller utilized in this study consists in switching loads on and off based on frequency measurements to provide frequency control to the system. The controller is decentralized, i.e., each load switches based on a local frequency measurement and is independent from the activity of the other loads. We assume that there are N loads and that the initial number of loads connected to the system is, for sake of example, $N_0 = N/2$. At every time step Δt , the load controllers decide with probability q whether to switch on or off. This probability q is a function of the frequency deviation Δf in the last period Δt , as follows. Let the quantity \bar{q} be:

$$\bar{q}(t) = \frac{\Delta f(t) + \Delta f_{\text{max}}}{2\Delta f_{\text{max}}} \quad (12)$$

where Δf_{max} is the maximum allowable frequency change such that beyond this point full load reserve with probability 1 will be used. The probability q is then calculate as:

$$q(t) = \begin{cases} 0 & \text{if } \bar{q}(t) \leq 0, \\ 1 & \text{if } \bar{q}(t) \geq 1, \\ \bar{q}(t) & \text{otherwise.} \end{cases} \quad (13)$$

Finally, each load generates a random number, u , between 1 and 0 using a uniform distribution and compares it with the current value of q . If $u \leq q$, the load switches on, and switches off otherwise. In this example, we assume $\Delta f_{\text{max}} = 0.2$ Hz and $\Delta f_{\text{min}} = -\Delta f_{\text{max}}$, where the nominal reference frequency is 60 Hz. Outside the range [59.8, 60.2] Hz, all loads are connected for the upper bound and disconnected for the lower bound.

The performance of the discrete controller discussed above depends on several parameters. We illustrate next the dynamic performance of the WSCC 9-bus system with inclusion of discrete loads and following a load outage of 25 MW.

First we consider the effect of time granularity and assume that the system includes 50×1 MW loads ($N_0 = 25 \times 1$ MW). Fig. 23 shows the trajectories of the frequency of the Center of Inertia (CoI) for two time steps, namely $\Delta t = 2.5$ s and $\Delta t = 0.1$ s. In this case, the smaller time step is beneficial for the overall frequency response of the system. In general one can conclude that large power steps and/or time steps distort more the frequency. It is important to note, however, that a small time step alone is not enough to lead to a smooth dynamic performance

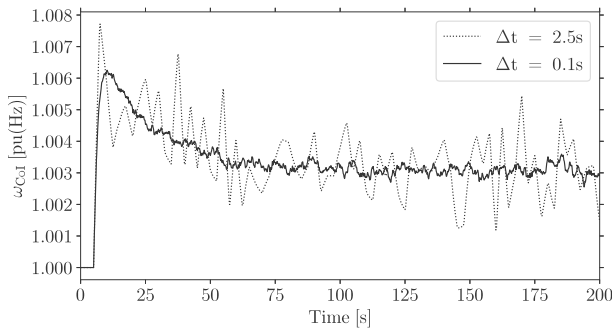

Fig. 23. Effect of the time periods between loads switches on the dynamic performance of the system [148].

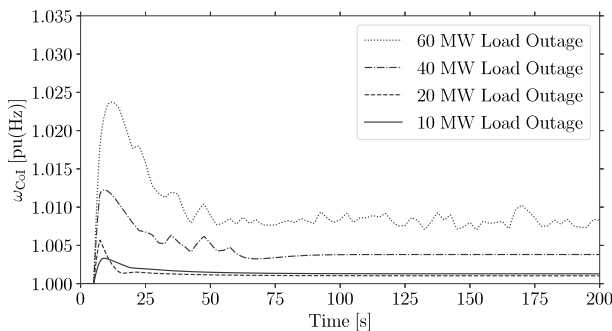

Fig. 24. Clusterized frequency load control combined with ESSs [148].

as it has to be accompanied also by a high load granularization. In particular, the level of granularity is particularly relevant for systems with low inertia where the effect of large “jumps” has bigger impact on frequency deviations [147].

On the other hand, end-user acceptance is also an important aspect that has to be taken into account. If the decentralized frequency control forces a load to switch too often, the consumer may experience the so-called *response fatigue* and will likely withdraw from the ancillary service program. A successful control strategy has thus to find a trade-off between two competing objectives: an adequate dynamic performance for the system operator and an adequate quality of supply for the consumer.

In [148], a solution based on the combination of clusterization of the loads and the inclusion of ESSs has been proposed to achieve this trade-off. The clusters allow increasing the time periods during which the loads are connected or disconnected from the grid, thus reducing the response fatigue. The ESSs, on the other hand, guarantee a smooth dynamic frequency response of the system. The combination of frequency controlled loads with the ESSs allows reducing the size, and thus the cost, of the ESSs. Fig. 24 illustrates the effect on the frequency of the center of inertia of the WSCC 9-bus system for various sizes of load outages of this combined clusterized frequency load control and ESSs.

9. Conclusion and outlook

9.1. Conclusions

The proliferation of millions of converter-interfaced resources pose new challenges and opportunities. Maintaining the stable operation of power systems requires a shift from the control of a few bulk generating units to the granular, decentralized, and stochastic control of millions of small controllable devices dispersed across the distribution and transmission systems. This paper explores how we can handle the *granularity*

and immense potential of such devices to offer micro-flexibility that can ensure the safe and stable operation of a power system. We identify key challenges and highlight issues that is essential for power system researchers to address. We summarize the key takeaways below.

- The effect of “granularization” of the devices is expected to lead to more complex and, maybe, unexpected dynamics in power systems. This is the result of the combined effect of the increase in the dynamic order of the system and nonlinearity. Apart from the flapping and quenching phenomena, which are mentioned in this work, the reader is also referred to the interesting paper [149] that describes *chimera states*. System operators and practitioners have thus to be prepared to observe new kind of instabilities in the system.
- The randomness of the behavior of the devices is both a potential issue for power systems but, if properly handled, potentially using a stochastic control, also an opportunity of the system.
- Stochastic controllers offer significant benefits (high scalability, fully decentralized, simple implementation) but also require a deep change in the operation of the grid. Both system operators and customers have to build their “trust” on the effectiveness of this kind of control. As the availability of a given resource and/or ancillary service becomes probabilistic, system operators have to move towards a fully probabilistic approach to define the stability of the system. Similarly, devices providing ancillary services have to accept that their actions are optimal *on average* along a sufficiently long period, not instantaneously.
- From the modeling and simulation point of view, “granularity” implies a move from continuous models to hybrid ones. This will make, very likely, time-domain simulations the only available tool to study the dynamic performance of the systems. The only alternative seems to be to find adequate continuous aggregated models that relax the discrete variable of make them superfluous. It is still unclear whether taking into account granularity also implies high dimensional models. Classes of “micro” devices whose behavior can be properly aggregated can lead to good approximations without the need of increasing the size of the equations. The effect of stochastic controllers on a high number of small devices can also be likely modeled using relatively simple aggregated models. There is, however, a gray region, i.e., when the actions of the devices are discrete (on/off) yet their size is not so small to make aggregated models precise enough. Spatial effects (e.g., the effect of the grid) as well as temporal effects (e.g., time elapsing among discrete events) appear to play a relevant role and should thus be carefully considered when defining aggregated models.
- A large enough fleet of small controllable devices allows for effective planning, modeling and simulation of available DERs flexibility even under stochastic loading conditions. Conversely, a reduced number of small controllable devices is much more prone to the stochasticity involved in their operation and, thus, a reduced available flexibility — besides having a smaller impact on the system overall.
- It is important to account for the characteristics at the devices-level with the appropriate detail, as they can impact both the control design phase (i.e. during simulations) and the real-world systems’ operation, see e.g. the importance of accurately parameterizing the tripping functions in aggregated distribution system equivalents.

9.2. Where does this lead us?

- We need to develop new models that can address the challenges emerging from the granular control of millions of devices. These models need to (i) capture the discrete behavior of the inverter-based resources (several of them, such as heat pumps, exhibit an on/off behavior), (ii) capture their stochasticity, and (iii) explicitly consider the time delays in measurements, communication,

and control. These models are not expected to replace completely the existing power system models. Instead they are expected to complement them. As usual, different time scales, system sizes, and levels of aggregation require capturing different phenomena and level of detail: for example, voltage control can be limited to a distribution feeder, but models pertaining to frequency control might need to capture the relevant details across voltage levels. The control of millions of devices at an aggregate level can potentially be considered continuous (if it is “random” enough), but this will then be needed to break down to individual actions at a device level; and at a device level, the models need to be discrete, stochastic, and consider the time delays.

- We need to design simulation approaches, or even revisit the design of numerical solvers, in order to handle the sheer complexity of large systems in a tractable way. Ultimate goal is to examine if, first, it is necessary, and, second, we are able to be able to simulate full T&D models, at an arbitrary level of granularity. Parallel computing in high performance computing clusters, and advanced co-simulation approaches with the help of cloud computing appear promising. Combining this with the strengths of the recently emerging quantum computing can possibly remove major computing barriers in the long term.
- We need to design suitable methods to accurately parameterize the aggregated and equivalent models. Approaches that can combine models based on first principles with data-driven methods appear the most promising. First principles can often not capture all salient characteristics of the components; these can be captured through measurements. At the same time, real data often lack instances close to the boundary conditions or unstable operation; physics-based models and simulation data generated from them can often be a good alternative. Grey-box modeling, physics-informed machine learning, and any method that can combine the strengths of physics-based with the data-driven modeling and control appear promising.
- We need to deliver methods that render the controllable devices trustworthy; this includes control approaches that can handle well stochasticity. This will help build the missing trust to the system operators and remove major barriers for the extraction of micro-flexibility. A relevant question, thus, is whether we can go beyond control approaches that work well “in expectation”.
- We need to design markets, that (i) can deal with the stochastic availability of flexible resources (e.g. reliability-aware markets), and (ii) can provide consumers with the right incentives to offer grid services.
- We need to develop and take advantage of the constantly expanding the IoT infrastructure. It has been widely demonstrated that coordinated control helps but several questions are currently waiting for an answer. For example, at the time of writing this work, it appears relevant to investigate how the IoT can be exploited to develop scalable control approaches that involve a significant degree of coordination, and how well these controls scale. At the same time, interconnectivity and dependence of the control signals on some sort of communications raises new concerns. In these context, ensuring cybersecurity and guaranteeing the privacy of data are critical requirements that are not fully solved yet.

Declaration of competing interest

The authors declare that they have no known competing financial interests or personal relationships that could have appeared to influence the work reported in this paper.

Data availability

No data was used for the research described in the article.

Acknowledgments

Federico Milano and Ioannis Dassios wish to thank Mr Tanveer Hussein for the help with Section 8.3 and for preparing Figs. 21 and 22.

References

- [1] T. Sadamoto, A. Chakraborty, T. Ishizaki, J.-i. Imura, Dynamic modeling, stability, and control of power systems with distributed energy resources: Handling faults using two control methods in tandem, *IEEE Control Syst. Mag.* 39 (2) (2019) 34–65.
- [2] F. Bouhafs, M. Mackay, M. Merabti, *Communication Challenges and Solutions in the Smart Grid*, Springer, 2014.
- [3] E. Kabalci, Y. Kabalci, *From Smart Grid to Internet of Energy*, Academic Press, 2019.
- [4] K.C. Budka, J.G. Deshpande, M. Thottan, *Communication Networks for Smart Grids: Making Smart Grid Real*, Springer, 2014.
- [5] N. Hatzigiorgiou, J.V. Milanović, C. Rahmann, V. Ajarapu, C. Cañizares, I. Erlich, D. Hill, I. Hiskens, I. Kamwa, B. Pal, P. Pourbeik, J.J. Sanchez-Gasca, A. Stankovic, T. Van Cutsem, C. Vournas, PES-TR77: Stability Definitions and Characterization of Dynamic Behavior in Systems with High Penetration of Power Electronic Interfaced Technologies, Tech. Rep., 2020.
- [6] M. Pai, A.M. Stankovic, *Power Electronics and Power Systems*, Springer, 2013.
- [7] T. Dragičević, S. Vazquez, P. Wheeler, Advanced control methods for power converters in DG systems and microgrids, *IEEE Trans. Ind. Electron.* 68 (7) (2021) 5847–5862.
- [8] M. Kuzlu, M. Pipattanasomporn, S. Rahman, Communication network requirements for major smart grid applications in han, nan and wan, *Comput. Netw.* 67 (2014) 74–88.
- [9] B. Sun, T. Dragičević, F.D. Frejedo, J.C. Vasquez, J.M. Guerrero, A control algorithm for electric vehicle fast charging stations equipped with flywheel energy storage systems, *IEEE Trans. Power Electron.* 31 (9) (2016) 6674–6685.
- [10] T. Kërçi, G. Tzounas, F. Milano, A dynamic behavioral model of the long-term development of solar photovoltaic generation driven by feed-in tariffs, *Energy* 256 (2022) 124506, [Online]. Available: <https://www.sciencedirect.com/science/article/pii/S0360544222014098>.
- [11] H.W.H. Hermanns, Demand-response management for dependable power grids, in: *Embedded Systems for Smart Appliances and Energy Management*, 2012.
- [12] F. Milano, F. Dörfler, G. Hug, D.J. Hill, G. Verbič, Foundations and challenges of low-inertia systems (invited paper), in: *2018 Power Systems Computation Conference, PSCC, 2018*, pp. 1–25.
- [13] M. Paolone, T. Gaunt, X. Guillaud, M. Liserre, S. Meliopoulos, A. Monti, T. Van Cutsem, V. Vittal, C. Vournas, Fundamentals of power systems modelling in the presence of converter-interfaced generation, *Electr. Power Syst. Res.* 189 (2020) 106811.
- [14] B.P. Ziegler, H. Praehofer, T.G. Kim, *Theory of Modeling and Simulation*, second ed., Elsevier Academic Press, Orlando, FL, 2000.
- [15] G.A. Wainer, P.J. Moisterman, *Discrete-Event Modeling and Simulation*, CRC Press, Boca Raton, FL, 2000.
- [16] J. Nutaro, H. Sarjoughian, Speedup of a sparse system simulation, in: *Proc. of 15th Workshop on Parallel and Distributed Simulation*, 2001, pp. 193–199.
- [17] Hong-Shan Zhao, Ji-Ping Zhang, Zeng-qiang Mi, Modeling and simulation for relay protection with the CD++ Toolkit, in: *International Conference on Power System Technology (PowerCon 2006)*, 2006, pp. 1–4.
- [18] J.J. Nutaro, *Building Software for Simulation*, Wiley, Hoboken, NJ, 2011.
- [19] F. Milano, I. Dassios, M. Liu, G. Tzounas, *Eigenvalue Problems in Power Systems*, CRC Press, 2020.
- [20] F. Milano, Hybrid control model of under load tap changers, *IEEE Trans. Power Deliv.* 26 (4) (2011) 2837–2844.
- [21] C. Vournas, N. Sakellariadis, Region of attraction in a power system with discrete lts, *IEEE Trans. Circuits Syst. I. Regul. Pap.* 53 (7) (2006) 1610–1618.
- [22] V. Donde, I.A. Hiskens, Analysis of tap-induced oscillations observed in an electrical distribution system, *IEEE Trans. Power Syst.* 22 (4) (2007) 1881–1887.
- [23] F. Milano, R. Zárate-Miñano, A systematic method to model power systems as stochastic differential algebraic equations, *IEEE Trans. Power Syst.* 28 (4) (2013) 4537–4544.
- [24] M. Adeen, F. Milano, Modeling of correlated stochastic processes for the transient stability analysis of power systems, *IEEE Trans. Power Syst.* 36 (5) (2021) 4445–4456.
- [25] M. Adeen, F. Milano, On the impact of auto-correlation of stochastic processes on the transient behavior of power systems, *IEEE Trans. Power Syst.* 36 (5) (2021) 4832–4835.
- [26] A. Bellen, M. Zennaro, *Numerical Methods for Delay Differential Equations*, Oxford Science Pubs., Oxford, 2003.
- [27] F. Milano, Small-signal stability analysis of large power systems with inclusion of multiple delays, *IEEE Trans. Power Syst.* 31 (4) (2016) 3257–3266.

- [28] J. Luisell, New examples of quenching in delay differential-delay equations having time-varying delay, in: Proceedings of the Fourth European Control Conference, Karlsruhe, Germany, 1999, pp. 1–5.
- [29] M. Liu, I. Dassios, G. Tzounas, F. Milano, Stability analysis of power systems with inclusion of realistic-modeling wams delays, *IEEE Trans. Power Syst.* 34 (1) (2019) 627–636.
- [30] A. Papachristodoulou, M.M. Peet, S. Niculescu, Stability analysis of linear system with time-varying delays: Delay uncertainty and quenching, in: Proceedings of the 46th IEEE Conference on Decision and Control, New Orleans, LA, USA, 2007, pp. 1–5.
- [31] U. Biccarri, E. Zuazua, A stochastic approach to the synchronization of coupled oscillators, *Front. Energy Res.* 8 (2020) [Online]. Available: <https://www.frontiersin.org/article/10.3389/feng.2020.00115>.
- [32] R. Jeter, I. Belykh, Synchronization in on-off stochastic networks: Windows of opportunity, *IEEE Trans. Circuits Syst. I. Regul. Pap.* 62 (5) (2015) 1260–1269.
- [33] G. Tzounas, R. Sipahi, F. Milano, Damping power system electromechanical oscillations using time delays, *IEEE Trans. Circuits Syst. I. Regul. Pap.* 68 (6) (2021) 2725–2735.
- [34] S.P. Meyn, P. Barooah, A. Bušić, Y. Chen, J. Ehren, Ancillary service to the grid using intelligent deferrable loads, *IEEE Trans. Automat. Control* 60 (11) (2015) 2847–2862.
- [35] A. Schlote, C. King, E. Crisostomi, R. Shorten, Delay-tolerant stochastic algorithms for parking space assignment, *IEEE Trans. Intell. Transp. Syst.* 15 (5) (2014) 1922–1935.
- [36] P. Ferraro, E. Crisostomi, R. Shorten, F. Milano, Stochastic frequency control of grid-connected microgrids, *IEEE Trans. Power Syst.* 33 (5) (2018) 5704–5713.
- [37] L. Herre, P. Pinson, S. Chatzivasileiadis, Reliability-aware probabilistic reserve procurement, *Electr. Power Syst. Res.* 212 (2022) 108345, [Online]. Available: <https://www.sciencedirect.com/science/article/pii/S0378779622005193>.
- [38] D. Ramasubramanian, Differentiating between plant level and inverter level voltage control to bring about operation of 100% inverter based resource grids, *Electr. Power Syst. Res.* 205 (2022) 107739, [Online]. Available: <https://www.sciencedirect.com/science/article/pii/S0378779621007203>.
- [39] D. Ramasubramanian, W. Baker, J. Matevosyan, S. Pant, S. Achilles, Asking for fast terminal voltage control in grid following plants could provide benefits of grid forming behavior, *IET Gener. Transm. Distrib.* n/a (n/a).
- [40] B. Johnson, T. Roberts, O. Ajala, A.D. Dominguez-Garcia, S. Dhople, D. Ramasubramanian, A. Tuohy, D. Divan, B. Kroposki, A generic primary-control model for grid-forming inverters: Towards interoperable operation & control, in: 2022 55th Hawaii International Conference on System Sciences, HICSS, 2022, pp. 1–10.
- [41] M. Lu, et al., A grid-compatible virtual oscillator controller: Analysis and design, in: 2019 IEEE Energy Conversion Congress and Exposition, ECCE, 2019, pp. 2643–2649.
- [42] D. Ramasubramanian, P. Pourbeik, E. Farantatos, A. Gaikwad, Simulation of 100% inverter-based resource grids with positive sequence modeling, *IEEE Electr. Mag.* 9 (2) (2021) 62–71.
- [43] J. Liu, Y. Miura, T. Ise, Comparison of dynamic characteristics between virtual synchronous generator and droop control in inverter-based distributed generators, *IEEE Trans. Power Electron.* 31 (5) (2016) 3600–3611.
- [44] R.W. Kenyon, A. Sajadi, A. Hoke, H.B. M. Open-source pscad grid-following and grid-forming (zero-inertia capable) inverters, in: 2021 IEEE Power and Energy Society General Meeting, IEEE, 2021, pp. 1–5.
- [45] National Grid Energy System Operator (ESO), GC0137: Minimum Specification Required for Provision of GB Grid Forming (GBGF) Capability (Formerly Virtual Synchronous Machine/VSM Capability), 2021, [Online]: <https://www.nationalgrideso.com/industry-information/codes/grid-code-oid/modifications/gc0137-minimum-specification-required>.
- [46] VDE VERLAG, VDE FNN Guideline: Grid forming behavior of HVDC systems and DC connected PPMs, 2019, [Online]: <https://www.vde-verlag.de/normen/0100511/vde-ar-n-4131-anwendungsregel-2019-03.html>.
- [47] F.E. Abrahamsen, Y. Ai, M. Cheffena, Communication technologies for smart grid: A comprehensive survey, *Sensors* 21 (23) (2021).
- [48] M. Ghorbanian, S.H. Dolatabadi, M. Masjedi, P. Siano, Communication in smart grids: A comprehensive review on the existing and future communication and information infrastructures, *IEEE Syst. J.* 13 (4) (2019) 4001–4014.
- [49] L. Tightiz, H. Yang, A comprehensive review on IoT protocols' features in smart grid communication, *Energies* 13 (11) (2020).
- [50] Communications Requirements of Smart Grid Technologies, Tech. Rep., U.S. Department of Energy, 2010.
- [51] V.C. Gungor, D. Sahin, T. Kocak, S. Ergut, C. Buccella, C. Cecati, G.P. Hancke, A survey on smart grid potential applications and communication requirements, *IEEE Trans. Ind. Inform.* 9 (1) (2013) 28–42.
- [52] N. Saputro, K. Akkaya, S. Uludag, A survey of routing protocols for smart grid communications, *Comput. Netw.* 56 (11) (2012) 2742–2771.
- [53] S. Ahmed, T.M. Gondal, M. Adil, S.A. Malik, R. Qureshi, A survey on communication technologies in smart grid, in: 2019 IEEE PES GTD Grand International Conference and Exposition Asia (GTD Asia), 2019, pp. 7–12.
- [54] M. Beaudin, H. Zareipour, Home energy management systems: A review of modelling and complexity, *Renew. Sustain. Energy Rev.* 45 (2015) 318–335.
- [55] H. Shareef, M.S. Ahmed, A. Mohamed, E. Al Hassan, Review on home energy management system considering demand responses, smart technologies, and intelligent controllers, *IEEE Access* 6 (2018) 24498–24509.
- [56] U. Zafar, S. Bayhan, A. Sanfilippo, Home energy management system concepts, configurations, and technologies for the smart grid, *IEEE Access* 8 (2020) 119271–119286.
- [57] Q.-D. Ho, Y. Gao, G. Rajalingham, T. Le-Ngoc, *Wireless Communications Networks for the Smart Grid*, Academic Press, 2014.
- [58] M.H. Wen, K.-C. Leung, V.O. Li, X. He, C.-C.J. Kuo, A survey on smart grid communication system, *APSIPA Trans. Signal Inf. Process.* 4 (2015) 7–12.
- [59] W. Wang, Y. Xu, M. Khanna, A survey on the communication architectures in smart grid, *Comput. Netw.* 55 (15) (2011) 3604–3629.
- [60] P. Kansal, A. Bose, Bandwidth and latency requirements for smart transmission grid applications, *IEEE Trans. Smart Grid* 3 (3) (2012) 1344–1352.
- [61] T.S. Ustun, *Advanced Communication and Control Methods for Future Smart Grids*, IntechOpen, 2016.
- [62] K. Ghanem, R. Asif, S. Ugwuanyi, J. Irvine, Bandwidth and security requirements for smart grid, in: 2020 IEEE PES Innovative Smart Grid Technologies Europe (ISGT-Europe), 2020, pp. 36–40.
- [63] S. Wang, X. Meng, T. Chen, Wide-area control of power systems through delayed network communication, *IEEE Trans. Control Syst. Technol.* 20 (2) (2012) 495–503.
- [64] C. Lu, X. Zhang, X. Wang, Y. Han, Mathematical expectation modeling of wide-area controlled power systems with stochastic time delay, *IEEE Trans. Smart Grid* 6 (3) (2015) 1511–1519.
- [65] L. Hu, Z. Wang, X. Liu, A.V. Vasilakos, F.E. Alsaadi, Recent advances on state estimation for power grids with unconventional measurements, *IET Control Theory Appl.* 11 (18) (2017) 3221–3232, [Online]. Available: <https://ietresearch.onlinelibrary.wiley.com/doi/abs/10.1049/iet-cta.2017.0629>.
- [66] E. Ekomwenrenren, H. Alharbi, T. Elgorashi, J. Elmighani, P. Aristidou, Stabilising control strategy for cyber-physical power systems, *IET Cyber-Phys. Syst.: Theory Appl.* 4 (3) (2019) 265–275, [Online]. Available: <https://ietresearch.onlinelibrary.wiley.com/doi/abs/10.1049/iet-cps.2018.5020>.
- [67] S. Oucheriah, Exponential stabilization of linear delayed systems using sliding-mode controllers, *IEEE Trans. Circuits Syst. - I* 50 (6) (2003) 826–830.
- [68] B. Liu, H.J. Marquez, Uniform stability of discrete delay systems and synchronization of discrete delay dynamical networks via razumikhin technique, *IEEE Trans. Circuits Syst. - I* 55 (9) (2008) 2795–2805.
- [69] V. Venkatasubramanian, H. Schattler, J. Zaborszky, A time-delay differential-algebraic phasor formulation of the large power system dynamics, in: *IEEE International Symposium on Circuits and Systems (ISCAS)*, Vol. 6, London, England, 1994, pp. 49–52.
- [70] F. Milano, M. Anghel, Impact of time delays on power system stability, *IEEE Trans. Circuits Syst. - I. Regul. Pap.* 59 (4) (2012) 889–900.
- [71] F. Milano, I. Dassios, Small-signal stability analysis for non-index 1 hessenberg form systems of delay differential-algebraic equations, *IEEE Trans. Circuits Syst. I. Regul. Pap.* 63 (9) (2016) 1521–1530.
- [72] S. Ayasun, C.O. Nwankpa, Probability of small-signal stability of power systems in the presence of communication delays, in: *International Conference on Electrical and Electronics Engineering (ELECO)*, Vol. 1, Bursa, Turkey, 2009, pp. 70–74.
- [73] H. Wu, G.T. Heydt, The impact of time delay on robust control design in power systems, in: *Proceedings of the IEEE PES Winter Meeting*, Vol. 2, Chicago, Illinois, 2002, pp. 1511–1516.
- [74] H. Wu, K.S. Tsakalis, G.T. Heydt, Evaluation of time delay effects to wide-area power system stabilizer design, *IEEE Trans. Power Syst.* 19 (4) (2004) 1935–1941.
- [75] M. Liu, I. Dassios, G. Tzounas, F. Milano, Model-independent derivative control delay compensation methods for power systems, *Energies* 13 (2) (2020).
- [76] F. Escobar, V. Juan, M.J. Garcia, P. Aristidou, G. Valverde, Coordination of DERs and FLs to support transmission voltages in emergency conditions, *IEEE Trans. Sustain. Energy* (2022).
- [77] A. Rajabi, L. Li, J. Zhang, J. Zhu, Aggregation of small loads for demand response programs — implementation and challenges: A review, in: 2017 IEEE International Conference on Environment and Electrical Engineering and 2017 IEEE Industrial and Commercial Power Systems Europe (EEEIC / I CPS Europe), 2017, pp. 1–6.
- [78] E. Vrettos, C. Ziras, G. Andersson, Fast and reliable primary frequency reserves from refrigerators with decentralized stochastic control, *IEEE Trans. Power Syst.* 32 (4) (2017) 2924–2941.
- [79] K. Yamashita, H. Renner, S. Martinez Villanueva, G. Lammert, P. Aristidou, J. Carvalho Martins, L. Zhu, L. David Pabon Ospina, T. Van Cutsem, Industrial recommendation of modeling of inverter-based generators for power system dynamic studies with focus on photovoltaic, *IEEE Power Energy Technol. Syst. J.* 5 (1) (2018) 1–10.
- [80] Modelling of Inverter-Based Generation for Power System Dynamic Studies, *JWG C4/C6.35/CIREP*, Tech. Rep. 727, 2018.
- [81] S. Mat Zali, J.V. Milanović, Generic model of active distribution network for large power system stability studies, *IEEE Trans. Power Syst.* 28 (3) (2013) 3126–3133.

- [82] F. Conte, F. D'Agostino, F. Silvestro, Operational constrained nonlinear modeling and identification of active distribution networks, *Electr. Power Syst. Res.* 168 (2019) 92–104, [Online]. Available: <https://www.sciencedirect.com/science/article/pii/S037877961830381X>.
- [83] A. Radovanovic, J.V. Milanovic, Exploratory study towards dynamic equivalent modelling of hybrid renewable energy source plant based on historical production data, in: 2019 IEEE Milan PowerTech, 2019, pp. 1–6.
- [84] E.O. Kontis, T.A. Papadopoulos, M.H. Syed, E. Guillo-Sansano, G.M. Burt, G.K. Papagiannis, Artificial-intelligence method for the derivation of generic aggregated dynamic equivalent models, *IEEE Trans. Power Syst.* 34 (4) (2019) 2947–2956.
- [85] G. Chaspierre, G. Denis, P. Panciatici, T. Van Cutsem, An active distribution network equivalent derived from large-disturbance simulations with uncertainty, *IEEE Trans. Smart Grid* 11 (6) (2020) 4749–4759.
- [86] N. Fulgencio, C. Moreira, L. Carvalho, J. Peças Lopes, Aggregated dynamic model of active distribution networks for large voltage disturbances, *Electr. Power Syst. Res.* 178 (2020) 106006, [Online]. Available: <https://www.sciencedirect.com/science/article/pii/S0378779619303256>.
- [87] G. Chaspierre, G. Denis, P. Panciatici, T. Van Cutsem, A dynamic equivalent of active distribution network: Derivation, update, validation and use cases, *IEEE Open Access J. Power Energy* 8 (2021) 497–509.
- [88] C. Zheng, S. Wang, Y. Liu, C. Liu, W. Xie, C. Fang, S. Liu, A novel equivalent model of active distribution networks based on lstm, *IEEE Trans. Neural Netw. Learn. Syst.* 30 (9) (2019) 2611–2624.
- [89] G. Mitrentsis, H. Lens, Data-driven dynamic models of active distribution networks using unsupervised learning techniques on field measurements, *IEEE Trans. Smart Grid* 12 (4) (2021) 2952–2965.
- [90] P. Wang, Z. Zhang, Q. Huang, X. Tang, W.-J. Lee, Robustness-improved method for measurement-based equivalent modeling of active distribution network, *IEEE Trans. Ind. Appl.* 57 (3) (2021) 2146–2155.
- [91] J.S. Chaverri, F. Escobar, J.A. García, G. Valverde, Comparison of ride-through characteristics in aggregate and detailed models of ders, in: 2021 IEEE URUCON, 2021, pp. 200–204.
- [92] M. Rylander, J. Smith, W. Sunderman, Streamlined method for determining distribution system hosting capacity, *IEEE Trans. Ind. Appl.* 52 (1) (2016) 105–111.
- [93] J. Le Baut, P. Zehetbauer, S. Kadam, B. Bletterie, N. Hatzigiorgiou, J. Smith, M. Rylander, Probabilistic evaluation of the hosting capacity in distribution networks, in: 2016 IEEE PES Innovative Smart Grid Technologies Conference Europe (ISGT-Europe), 2016, pp. 1–6.
- [94] A. O'Connell, J. Smith, A. Keane, Distribution feeder hosting capacity analysis, in: 2017 IEEE PES Innovative Smart Grid Technologies Conference Europe (ISGT-Europe), 2017, pp. 1–6.
- [95] J. Deboever, S. Grijalva, J. Peppanen, M. Rylander, J. Smith, Practical data-driven methods to improve the accuracy and detail of hosting capacity analysis, in: 2018 IEEE 7th World Conference on Photovoltaic Energy Conversion (WCPEC) (A Joint Conference of 45th IEEE PVSC, 28th PVSEC 34th EU PVSEC), 2018, pp. 3676–3681.
- [96] M.U. Qureshi, A. Kumar, S. Grijalva, J. Deboever, J. Peppanen, M. Rylander, Fast hosting capacity analysis considering over-voltage criteria and impact of regulating devices, in: 2020 IEEE/PES Transmission and Distribution Conference and Exposition (T D), 2020, pp. 1–5.
- [97] M.U. Qureshi, A. Kumar, S. Grijalva, J. Deboever, J. Peppanen, M. Rylander, Fast hosting capacity analysis for thermal loading constraint using sensitivity-based decomposition method, in: 2020 52nd North American Power Symposium, NAPS, 2021, pp. 1–5.
- [98] A. Bhandari, D. Ramasubramanian, V. Singhvi, A. Gaikwad, Considerations for electric utilities to determine energy storage size for transmission deferral to increase hosting capacity, in: 2020 52nd North American Power Symposium, NAPS, 2021, pp. 1–6.
- [99] P. Cicilio, E. Cotilla-Sanchez, B. Vaagensmith, J. Gentle, Transmission hosting capacity of distributed energy resources, *IEEE Trans. Sustain. Energy* 12 (2) (2021) 794–801.
- [100] The New Aggregated Distributed Energy Resources (der_a) Model for Transmission Planning Studies: 2019 Update, Tech. Rep. 3002015320, Electric Power Research Institute, Palo Alto, CA, 2019.
- [101] P. Pourbeik, Proposal for der_a model: memo issued to WECC REMTF MVWG and EPRI P173.003, 2018, url: https://www.wecc.biz/Reliability/DER_A_Final.pdf.
- [102] I. Alvarez-Fernandez, D. Ramasubramanian, A. Gaikwad, J. Boemer, Parameterization of aggregated distributed energy resources (der_a) model for transmission planning studies, in: CIGRE US National Committee 2018 Grid of the Future Symposium, 2018, pp. 1–6.
- [103] Technical Reference on the Composite Load Model, Tech. Rep. 3002019209, Electric Power Research Institute, Palo Alto, CA, 2020.
- [104] P. Pourbeik, Developing dynamic load models for the Australian Eastern interconnected system, 2019, URL: <https://aemo.com.au/-/media/files/initiatives/der/2020/aemo-load-modeling-062819-final.pdf?la=en>.
- [105] P. Pourbeik, D.J. Ryan, F. Brnadic, J. Riesz, B. Badrzadeh, J. Lu, Developing dynamic load models for the Australian national electricity market with a focus on distributed energy resources, *CIGRÉ Sci. Eng.* 20 (2021) 91–105.
- [106] R. Quint, S. Shao, J. Skeath, B. Marszalkowski, D. Ramasubramanian, I. Green, M. Elnashar, P. Wang, S. Xu, Verification process for der modeling in interconnection-wide base case creation, *CIGRÉ Sci. Eng.* 18 (2020) 51–61.
- [107] R.F. Arritt, R.C. Dugan, The IEEE 8500-node test feeder, in: *IEEE PES T D* 2010, 2010, pp. 1–6.
- [108] Towards Prediction of Generic Parameters for Aggregated DER Model (DER_A), Tech. Rep. 3002019451, Electric Power Research Institute, Palo Alto, CA, 2020.
- [109] D. Ramasubramanian, I. Alvarez-Fernandez, P. Mitra, A. Gaikwad, J.C. Boemer, Ability of positive sequence aggregated distributed energy resource model to represent unbalanced tripping of distribution inverters, in: 2019 IEEE Power Energy Society General Meeting, PESGM, 2019, pp. 1–5.
- [110] P. Dattaray, D. Ramasubramanian, P. Mitra, J.C. Boemer, M. Bello, A. Gaikwad, Bulk system impact of der and loads using t & d cosimulation and aggregate models, in: 2021 IEEE PES Innovative Smart Grid Technologies Europe (ISGT Europe), 2021, pp. 01–05.
- [111] D. Ramasubramanian, P. Mitra, P. Dattaray, M. Bello, J.C. Boemer, A. Gaikwad, Analyzing impact of der on fidvr - comparison of emt simulation of a combined transmission and distribution grid with aggregated positive sequence models, *Electr. Power Syst. Res.* 201 (2021) 107534.
- [112] D. Ramasubramanian, P. Dattaray, P. Mitra, A. Gaikwad, J.C. Boemer, Partial frequency trip in aggregated DER model: Is it required? 2020, url: <https://www.wecc.org/Administrative/Ramasubramanian%20-%20Partial%20Frequency%20Trip%20in%20Aggregated%20DER%20Model.pdf>.
- [113] I. Alvarez-Fernandez, D. Ramasubramanian, W. Sun, A. Gaikwad, J.C. Boemer, S. Kerr, D. Haughton, Impact analysis of DERs on bulk power system stability through the parameterization of aggregated DER_a model for real feeders, *Electr. Power Syst. Res.* 189 (2020).
- [114] N. Pilatte, P. Aristidou, G. Hug, Tdnetgen: An open-source, parametrizable, large-scale, transmission, and distribution test system, *IEEE Syst. J.* 13 (1) (2019) 729–737.
- [115] F. Escobar, J. García, J.M. Viquez, G. Valverde, P. Aristidou, A combined high-, medium-, and low-voltage test system for stability studies with ders, *Electr. Power Syst. Res.* 189 (2020) 106671.
- [116] H. Li, J.L. Wert, A.B. Birchfield, T.J. Overbye, T.G.S. Roman, C.M. Domingo, F.E.P. Marcos, P.D. Martinez, T. Elgindy, B. Palmintier, Building highly detailed synthetic electric grid data sets for combined transmission and distribution systems, *IEEE Open Access J. Power Energy* 7 (2020) 478–488.
- [117] A.K. Bharati, V. Ajarapu, Smtc co-simulation framework with helics for future-grid analysis and synthetic measurement-data generation, *IEEE Trans. Ind. Appl.* 58 (1) (2022) 131–141.
- [118] P. Aristidou, T. Van Cutsem, Dynamic simulations of combined transmission and distribution systems using decomposition and localization, in: 2013 IEEE Grenoble Conference, 2013, pp. 1–6.
- [119] H. Sun, Q. Guo, B. Zhang, Y. Guo, Z. Li, J. Wang, Master-slave-splitting based distributed global power flow method for integrated transmission and distribution analysis, *IEEE Trans. Smart Grid* 6 (3) (2015) 1484–1492.
- [120] R. Venkatraman, S.K. Khaitan, V. Ajarapu, Dynamic co-simulation methods for combined transmission-distribution system with integration time step impact on convergence, *IEEE Trans. Power Syst.* 34 (2) (2019) 1171–1181.
- [121] R. Huang, R. Fan, J. Daily, A. Fisher, J. Fuller, Open-source framework for power system transmission and distribution dynamics co-simulation, *IET Gener. Transm. Distrib.* 11 (12) (2017) 3152–3162, [Online]. Available: <https://ietresearch.onlinelibrary.wiley.com/doi/abs/10.1049/iet-gtd.2016.1556>.
- [122] G. Krishnamoorthy, A. Dubey, Transmission-distribution cosimulation: Analytical methods for iterative coupling, *IEEE Syst. J.* 14 (2) (2020) 2633–2642.
- [123] A.K. Bharati, V. Ajarapu, A scalable multi-timescale t & d co-simulation framework using helics, in: 2021 IEEE Texas Power and Energy Conference, TPEC, 2021, pp. 1–6.
- [124] Y. Zhou, F. Feng, P. Zhang, Quantum electromagnetic transients program, *IEEE Trans. Power Syst.* 36 (4) (2021) 3813–3816.
- [125] B. Sævarsson, S. Chatzivasileiadis, H. Johannsson, J. Østergaard, Quantum computing for power flow algorithms: Testing on real quantum computers, in: 2022 IREP Symposium - Bulk Power System Dynamics and Control - XI, IREP, 2022, available online: <https://arxiv.org/pdf/2204.14028.pdf>.
- [126] Z.-S. Hou, Z. Wang, From model-based control to data-driven control: Survey, classification and perspective, *Inform. Sci.* 235 (2013) 3–35, [Online]. Available: <https://www.sciencedirect.com/science/article/pii/S0020025512004781>.
- [127] G.S. Misyris, A. Venke, S. Chatzivasileiadis, Physics-informed neural networks for power systems, in: 2020 IEEE Power & Energy Society General Meeting, PESGM, 2020, pp. 1–5.
- [128] J. Stiasny, G.S. Misyris, S. Chatzivasileiadis, Physics-informed neural networks for non-linear system identification for power system dynamics, in: 2021 IEEE Madrid PowerTech, 2021, pp. 1–6.
- [129] A. Annaswamy, IEEE vision for smart grid control: 2030 and beyond roadmap, in: *IEEE Vision for Smart Grid Control: 2030 and beyond Roadmap*, 2013, pp. 1–12.
- [130] Technical Information Bulletin 04-1: Supervisory Control and Data Acquisition (SCADA) Systems, Tech. Rep., National Communications System, 2004, [60].

- [131] F. Bouhafs, M. Mackay, M. Merabti, Links to the future: Communication requirements and challenges in the smart grid, *IEEE Power Energy Mag.* 10 (1) (2012) 24–32.
- [132] G.W. Arnold, Challenges and opportunities in smart grid: A position article, *Proc. IEEE* 99 (6) (2011) 922–927.
- [133] D. Hill, T. Liu, G. Verbic, Smart grids as distributed learning control, in: 2012 IEEE Power and Energy Society General Meeting, 2012, pp. 1–8.
- [134] E. Borgia, The internet of things vision: Key features, applications and open issues, *Comput. Commun.* 54 (2014) 1–31.
- [135] P. McDaniel, S. McLaughlin, Security and privacy challenges in the smart grid, *IEEE Secur. Priv.* 7 (3) (2009) 75–77.
- [136] P.P. Ray, A survey on Internet of Things architectures, *J. King Saud Univ. - Comput. Inf. Sci.* (2016).
- [137] D.K. Molzahn, F. Dörfler, H. Sandberg, S.H. Low, S. Chakrabarti, R. Baldick, J. Lavaei, A survey of distributed optimization and control algorithms for electric power systems, *IEEE Trans. Smart Grid* 8 (6) (2017) 2941–2962.
- [138] S. Haben, S. Arora, G. Giasemidis, M. Voss, D. Vukadinović Greetham, Review of low voltage load forecasting: Methods, applications, and recommendations, *Appl. Energy* 304 (2021) 117798.
- [139] A. Gómez-Expósito, A. Conejo, C. Cañizares, *Electric Energy Systems: Analysis and Operation*, CRC Press, 2020.
- [140] P. Jahangiri, D.C. Aliprantis, Distributed Volt/VAr control by PV inverters, *IEEE Trans. Power Syst.* 28 (3) (2013) 3429–3439.
- [141] M. Cheng, J. Wu, S.J. Galsworthy, C.E. Ugalde-Loo, N. Gargov, W.W. Hung, N. Jenkins, Power system frequency response from the control of bitumen tanks, *IEEE Trans. Power Syst.* 31 (3) (2016) 1769–1778.
- [142] I. Beil, I. Hiskens, S. Backhaus, Frequency regulation from commercial building HVAC demand response, *Proc. IEEE* 104 (4) (2016) 745–757.
- [143] E. Vrettos, C. Ziras, G. Andersson, Fast and reliable primary frequency reserves from refrigerators with decentralized stochastic control, *IEEE Trans. Power Syst.* 32 (4) (2017) 2924–2941.
- [144] Z.A. Obaid, L.M. Cipcigan, M.T. Muhssin, S.S. Sami, Development of a water heater population control for the demand-side frequency control, in: 2017 IEEE PES ISGT Europe, 2017, pp. 1–6.
- [145] M.T. Muhssin, L. Cipcigan, N. Jenkins, S. Slater, M. Cheng, Z. Obaid, Dynamic frequency response from controlled domestic heat pumps, *IEEE Trans. Power Syst.* PP (99) (2018) 1.
- [146] D. Angeli, P.A. Kountouriotis, A stochastic approach to dynamic-demand refrigerator control, *IEEE Trans. Control Syst. Technol.* 20 (3) (2012) 581–592.
- [147] A. Ulbig, T.S. Borsche, G. Andersson, Impact of low rotational inertia on power system stability and operation, *IFAC Proc. Vol.* 47 (3) (2014) 7290–7297.
- [148] J. McMahon, T. Kërçi, F. Milano, Combining flexible loads with energy storage systems to provide frequency control, in: 2021 IEEE PES Innovative Smart Grid Technologies - Asia (ISGT Asia), 2021, pp. 1–5.
- [149] D. Abrams, S.H. Strogatz, Chimera states in a ring of nonlocally coupled oscillators, *Int. J. Bifurcation Chaos* 16 (01) (2006) 21–37.